

Staron® Fabrication Manual

SN-804-2020

PREFACE

This manual is designed to provide necessary guidelines for optimal fabrication, installation, and performance of Lotte Chemical Corp. Staron® solid surface products, per their unique chemical composition and properties.

Though the information contained herein is deemed reliable, none of the contents--including but not limited to the instructions, techniques, graphics, and recommendations--is to be understood as implying legal liability of fitness for a specific purpose, any other type of warranty, or being complete or absolute in its range and nature of information. Depending on the user's particular application, all necessary measures must be taken to verify and test the adequacy for such needs or application at his/her discretion.

Any information or recommendation herein is strictly for purposes of reference and as such, of Lotte Chemical Corp. and its affiliates assume no responsibility for its suitability or accuracy or the use of such information for products other than of Lotte Chemical Corp. Staron® solid surfaces.

TABLE OF CONTENTS

Products

- 1.1 Staron® Sheets
- 1.2 Staron® Sinks & Bowls
- 1.3 Staron® adhesive

QUALITY INSPECTION

- 2.1 Staron® Sheet Quality Inspection
- 2.2 Staron® Sink & Bowl Quality Inspection

SAFETY HANDLING AND STORAGE

- 3.1 Handling Staron® Sheets
- 3.2 Handling Staron® Sinks & Bowls
- 3.3 Storing Staron® Sheets
- 3.4 Storing Staron® Sinks & Bowls

TOOLS AND ACCESSORIES

- 4.1 Basic Fabrication Shop
- 4.2 Tool Check List

SITE PREPARATION

- 5.1 Site Inspection
- 5.2 Leveling
- 5.3 Required Tools

TEMPLATES

- 6.1 Measurement Templates
- 6.2 Luann Strip Templates
- 6.3 Cardboard Templates
- 6.4 Digital Templates
- 6.5 Tools Needed

SEAM PLACEMENT

- 7.1 Planning
- 7.2 Positioning

CUTTING

- 8.1 Tools Needed
- 8.2 Overview

SEAMING

- 9.1 Tools Needed
- 9.2 Wavy Edge Bit
- 9.3 Straight Cut
- 9.4 Mirror Cut
- 9.5 Edge Preparation
- 9.6 Seam Adhesive
- 9.7 Ski Routing and Sanding
- 9.8 Seam Plate

EDGE DETAILS AND BUILDUPS

- 10.1 Stacked Edge
- 10.2a Drop Edge (Standard)
- 10.2b Drop Edge (Rabbit Method)
- 10.3 V-Grooving
- 10.4 Inside Corner Buildup
- 10.5 Decorative Edge Profile

INLAYS

- 11.1 Overview
- 11.2 Hard Inlays
- 11.3 Poured Inlays

SINK & BOWL CUTOUTS

- 12.1 Tools Needed
- 12.2 Making Cutout Templates
- 12.3 Making Cutouts Using Templates
- 12.4 Making Cutouts Freehand

COOKTOP CUTOUTS

- 13.1 Cooktop Templates
- 13.2 Cooktop Cutout
- 13.3 High Strength Support
- 13.4 Final Rout
- 13.5 Sanding
- 13.6 Potential Problems
- 13.7 Prevention

TABLE OF CONTENTS

SUPPORT

- 14.1 Countertop Support
- 14.2 Overhang Support

STARON® SHAPES

- 15.1 Handling Staron® Sink & Bowl

FASTENING TO STARON®

- 16.1 Stainless Steel Sinks
- 16.2 Cast Iron Sinks
- 16.3 China Bowls
- 16.4 Wood Insert
- 16.5 Wood Edge
- 16.6 Handicap Bar & Handles Shower Doors
- 16.7 Soap Dishes Shower Caddies
- 16.8 Tiles Hot Pot Areas

BACKSPLASHES

- 17.1 Loose Backsplash
- 17.2 Coved Backsplash
 - 17.2-1 Method (I)
 - 17.2-2 Method (II)
 - 17.2-3 Method (III)
 - 17.2-4 Method (IV)
- 17.3 Full Height Backsplash

FINISHING AND POLISHING

- 18.1 Finishing
- 18.2 Polishing

INSTALLATION

- 19.1 Transportation
- 19.2 Site Preparation
- 19.3 Carrying & Positioning
- 19.4 Dry Fitting
- 19.5 Seam Plate
- 19.6 Faucet Holes
- 19.7 Final Placement
- 19.8 Anchoring Dishwasher
- 19.9 Preparing Cooktop Cutout
- 19.10 Do's and Don'ts

VERTICAL APPLICATIONS

- 20.1 Overview
- 20.2 Fabrication & Installation

COMMERCIAL APPLICATIONS

- 21.1 Food Service Application (Hot Wells)
- 21.2 Food Service Application (Cold Wells)

THERMOFORMING

- 22.1 Material Preparation
- 22.2 Mould Preparation
- 22.3 Oven
- 22.4 Oven Calibration
- 22.5 Thermoforming
- 22.6 Thermoforming Checklist

REPAIR

- 23.1 Introduction
- 23.2 Inside Corner Repair
- 23.3 Bevel Repair
- 23.4 Solid Surface Sink Replacement

Warranty

- 24.1 10-YEAR LIMITED" WARRANTY (Residential)
- 24.2 10-YEAR LIMITED" WARRANTY (Commercial)
- 24.3 Complaint Handling Procedure
- 24.4 Specific Warranty Stipulations

TECHNICAL BULLETIN

- Choosing ideal colours (Dark colours)
- Pearl particulate colours
- Supreme collection
- Translucent colours
- Mosaic & Earthen series
- Adhesive
- Care and maintenance

1.1 Staron® Sheets

□ Dimensions

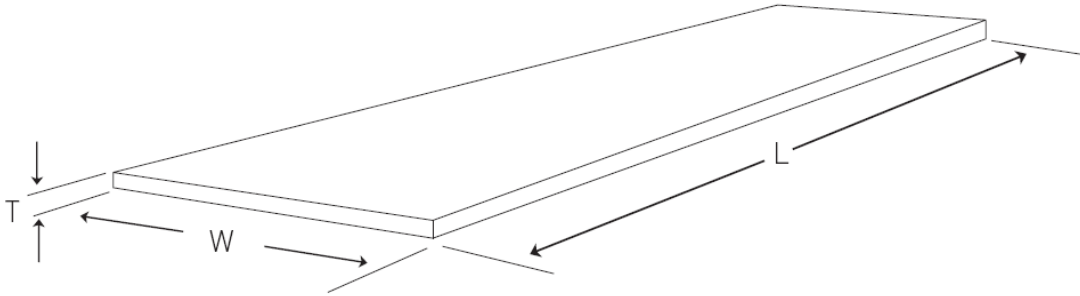

GROUP	THICKNESS INCH (mm)	WIDTH INCH (mm)	LENGTH INCH (mm)	WEIGHT LBS (kg)
Solid	1/4" (6 mm)	30"(760 mm)	98" (2,500 mm)	42.5 lbs (19.3 kg)
	1/2" (12 mm)		145" (3,680 mm)	125.0 lbs (56.7 kg)
	3/4" (19mm)		145" (3,680 mm)	197.9 lbs (89.8 kg)
Sanded	1/4" (6 mm)	30"(760 mm)	98" (2,500 mm)	41.3 lbs (18.7 kg)
	1/2" (12 mm)		145" (3,680 mm)	121.6 lbs (55.1 kg)
	3/4" (19mm)		145" (3,680 mm)	192.5 lbs (87.2 kg)
Aspen	1/4" (6 mm)	30"(760 mm)	98" (2,500 mm)	42.1 lbs (19.1 kg)
	1/2" (12 mm)		145" (3,680 mm)	123.7 lbs (56.1 kg)
Pebble	1/2" (12 mm)	30"(760 mm)	145" (3,680 mm)	114.0 lbs (51.7 kg)
Quarry	1/2" (12 mm)	30"(760 mm)	145" (3,680 mm)	116.4 lbs (52.8 kg)
Tempest	1/2" (12 mm)	30"(760 mm)	145" (3,680 mm)	117.3 lbs (53.2 kg)

- 1/8"(3mm) ~ 1/4" (6mm) thickness sheet is not recommended for countertops or other horizontal applications.
- 3/8"(9mm) thickness is not recommended for horizontal application with heat source.
- 3/4" (19mm) thick colors are limited to Solid Bright White, Solid Pure White, Solid Quasar White, Solid Pearl, Sanded Gray, Sanded Sahara, Metallic Yukon.

□ Special size (Colour: Bright White, only)

(Unit: mm)

	910 (W)	930 (W)	1,350 (W)	1,520 (W)
3 (T)	910*2500	930*3000		
4 (T)	910*2500	930*3000		
6 (T)		930*2500	1350*2500	
		930*3000		
9 (T)		930*2750	1350*2500	1500*2500
		930*3680	1350*3660	1500*3660
12 (T)		930*3680	1350*2500	1500*2500
			1350*3660	1500*3660

- Ordering the special size product requires MOQ (minimum order quantity). Please contact Staron distributor.

□ Sheet colours

Staron has a variety of colours. Please refer to the following instructions of each colour groups.

➔ Note

❖ marked colours are dark and chromatic colours. These colours will show scratches, haziness more than light colours. Please refer to technical bulletin "SN-315 Choosing ideal colour" and avoid to apply for heavy traffic area.

Solid



Sanded

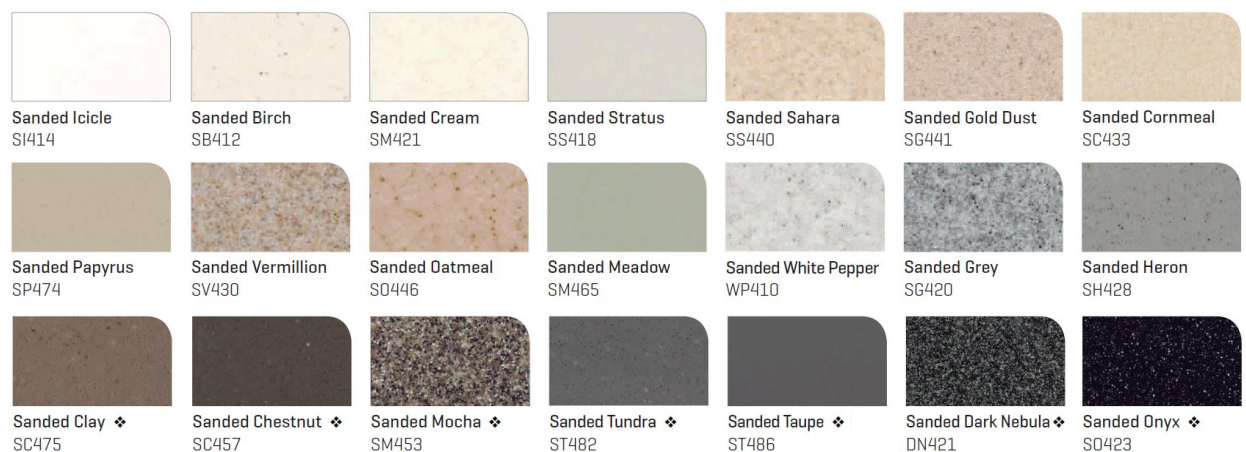

Aspen



Pebble

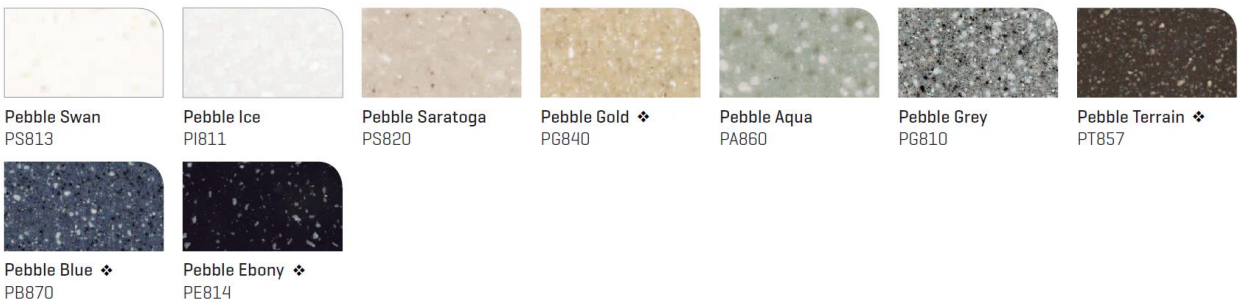

Quarry

- Quarry Starred and Quarry Minette are pearl particulate colours. Please refer to Technical bulletin " SN-305: Directional pattern of Pearl particulate"

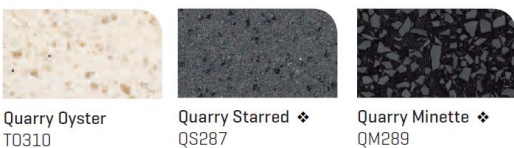

Mosaic and Earthen

- These colours have a special type of chip in the product. Please refer to Technical bulletin " SN-306: Mosaic and Earthen series"

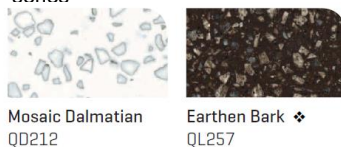

SN-804-2020

Metallic

- These colours have a glittering pearl particulate in the product. Please refer to Technical bulletin " SN-305: Directional pattern of Pearl particulate"



Tempest

- Tempest Caviar is pearl particulate colours. Please refer to Technical bulletin " SN-305: Directional pattern of Pearl particulate"

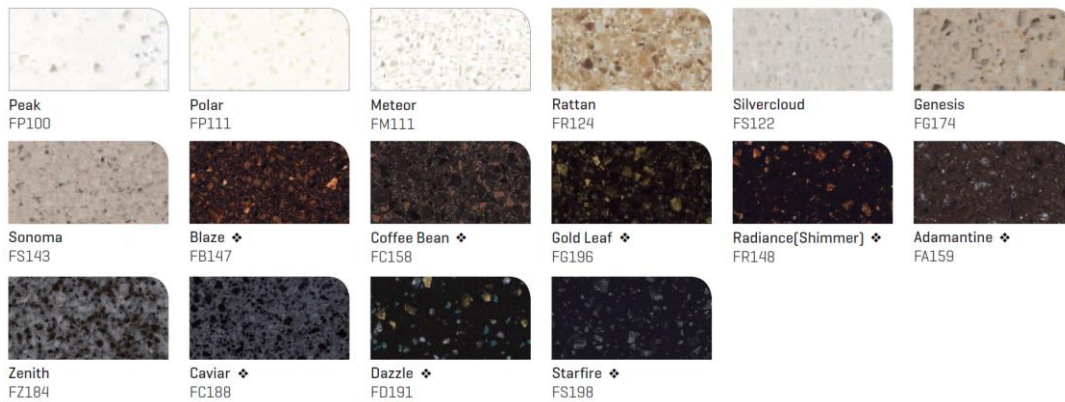

Translucent colours

- Transmittance of these colours is higher than other colours. Please refer to Technical bulletin " SN-321: Characteristics of Translucent colours"

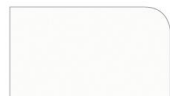

Dazzling White
SD001



Morning Sky VM114

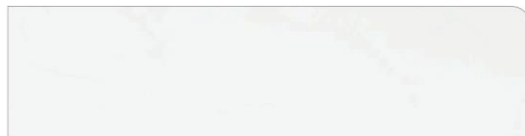

Cotton White VC110



Delphi VD111



Ocean View V0171

Supreme

- These colours have a irregular vein pattern all through the slab. Please refer to Technical bulletin " SN-311: Fabrication and Installation of Supreme"



Morning Sky VM114

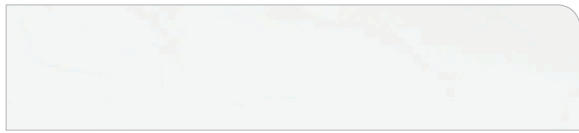

Cotton White VC110



Delphi VD111



Cloudbank VC118



Beige Granite VB172



Magnolia VM143



Ocean View VD171



Natural Bridge VN144



Dandelion VD175



Pastoral VP177

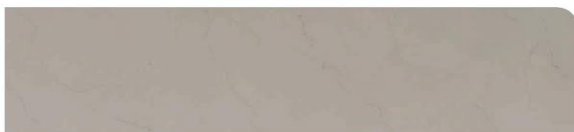

Urban Grey VU127

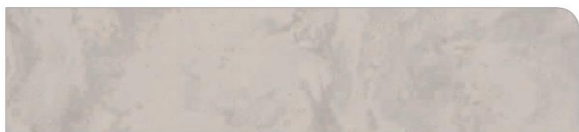

Dawn VD126



Loam VL155



Presto VP159

SN-804-2020

1.2 Staron® Sinks and Bowls

- Available in five colors
- Bright White / Ivory / Pearl / Quasar White / Pure White

□ Staron Bowls

A3211

Bowl

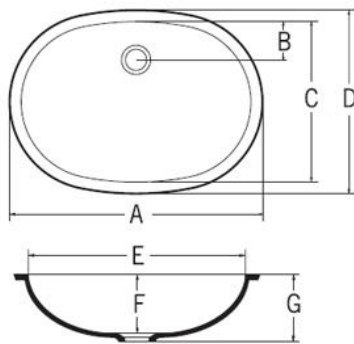

A	21.57in (548mm)
B	3.38in (86mm)
C	14.01in (356mm)
D	15.59in (396mm)
E	20.00in (508mm)
F	6.14in (156mm)
G	6.81in (173mm)

A3181

Bowl

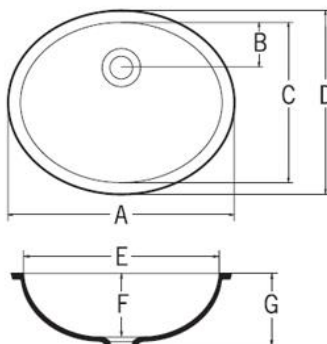

A	18.18in (462mm)
B	3.70in (94mm)
C	13.22in (336mm)
D	14.80in (376mm)
E	16.61in (422mm)
F	5.47in (139mm)
G	6.14in (156mm)

A2311

Sink

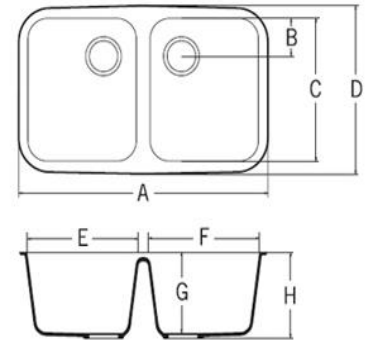

A	31.25in (794mm)
B	4.33in (110mm)
C	16.57in (421mm)
D	18.93in (481mm)
E	13.70in (348mm)
F	13.70in (348mm)
G	9.84in (250mm)

□ **Staron Sinks**

A1121

Sink

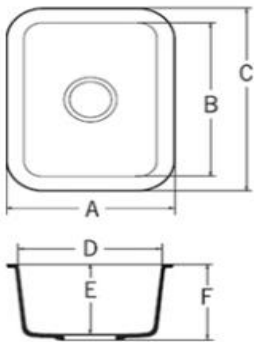

A	12.83in (326mm)
B	14.01in (356mm)
C	16.37in (416mm)
D	10.47in (266mm)
E	6.49in (165mm)
F	7.08in (180mm)

A1231

Sink

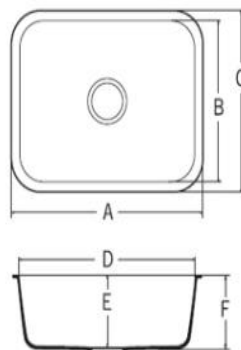

A	23.30in (592mm)
B	16.61in (422mm)
C	18.97in (482mm)
D	20.94in (532mm)
E	7.36in (187mm)
F	7.95in (202mm)

A1181

Sink

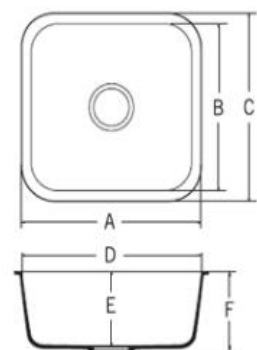

A	18.11in (460mm)
B	15.75in (400mm)
C	18.11in (460mm)
D	15.75in (400mm)
E	8.18in (208mm)
F	8.85in (225mm)

□ Staron Sinks

B3290

Sink

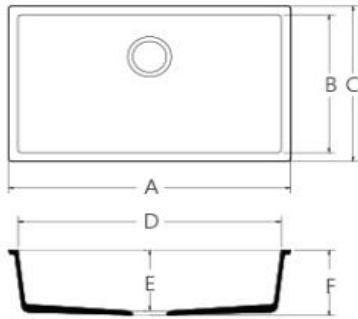

A	29.52in (750mm)
B	15.75in (400mm)
C	17.64in (448mm)
D	27.48in (698mm)
E	7.28in (185mm)
F	7.87in (200mm)

B3180

Sink

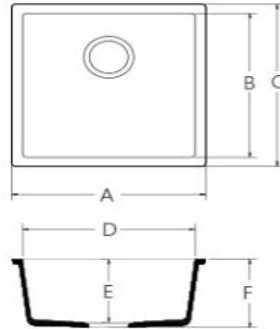

A	17.67in (449mm)
B	15.75in (400mm)
C	17.67in (449mm)
D	15.75in (400mm)
E	6.89in (175mm)
F	7.48in (190mm)

1.3 Staron® Adhesive

Staron® adhesive name is following its own Staron® sheet name. → Aspen Glacier sheet's adhesive name is also Aspen Glacier. Sharing adhesive can be an alternative. i.e. Adhesive (Pebble Frost) can be used for sheet (Aspen Glacier)

➔ **Note**

Adhesive colour has been matched for 0.1mm seam line width condition. If seam line is wider than 01.mm, adhesive colour on seam line may visible. For more detailed information please refer technical bulletin "SN-307 Staron adhesive user manual"

Staron® Name	CODE	Adhesive Name	Sharing	Staron® Name	CODE	Adhesive Name	Sharing
Aspen Fiesta	AF611	Aspen Fiesta	○	Earthen Bark	QL257	Earthen Bark	○
Aspen Glacier	AG612	Aspen Glacier		Supreme Loam	VL155	Supreme Loam	
Aspen Gold Rush	AG614	Aspen Gold Rush		Pebble Terrain	PT857	Pebble Terrain	
Supreme Dawn	VD126	Supreme Dawn		Tempest Adamantine	FA159	Tempest Adamantine	
Metallic Yukon	EY510	Metallic Yukon		Metallic Beach	EB545	Metallic Beach	
Pebble Coral	PC817	Pebble Coral		Pebble Aqua	PA860	Pebble Aqua	
Pebble Frost	PF812	Pebble Frost		Pebble Saratoga	PS820	Pebble Saratoga	
Pebble Ice	PI811	Pebble Ice		Sanded Grey	SG420	Sanded Grey	
Pebble Lagoon	PL814	Pebble Lagoon		Sanded Sahara	SS440	Sanded Sahara	
Quarry Rocksalt	TR305	Quarry Rocksalt		Pebble Swan	PS813	Pebble Swan	
Sanded Birch	SB412	Sanded Birch		Tempest Confection	FC116	Tempest Confection	
Sanded Cream	SM421	Sanded Cream		Tempest Horizon	FH114	Tempest Horizon	
Sanded Dover	SD413	Sanded Dover		Tempest Meteor	FM111	Tempest Meteor	
Tempest Bamboo	FB173	Tempest Bamboo		Tempest Pinnacle	FP112	Tempest Pinnacle	
Tempest Shell	FS115	Tempest Shell		Aspen Lily	AL645	Aspen Lily	
Supreme Morning Sky	VM114	Supreme Morning Sky		Pebble Caper	PC821	Pebble Caper	
Natural	SV041	Natural		Sanded Icicle	SI414	Sanded Icicle	
Pearl	SP011	Pearl		Tempest Sonoma	FS143	Tempest Sonoma	
Quarry Esker	QE240	Quarry Esker		Aspen Brown	AB632	Aspen Brown	
Quarry Oyster	TO310	Quarry Oyster	Pebble Gold	PG840	Pebble Gold		
Sanded Linen	SL443	Sanded Linen	Sanded Gold Dust	SG441	Sanded Gold Dust		
Sanded Stratus	SS418	Sanded Stratus	Sanded Vermillion	SV430	Sanded Vermillion		
Tempest Glimmer	FG144	Tempest Glimmer	Pebble Chiffon	PC842	Pebble Chiffon		
Tempest Silvercloud	FS122	Tempest Silvercloud	Pebble Flan	PF870	Pebble Flan		
Tusk	ST015	Tusk	Pebble Fresco	PF844	Pebble Fresco		
Metallic Cosmos	EC596	Metallic Cosmos	Quarry Ridge	QR278	Quarry Ridge		
Onyx	ON095	Onyx	Aspen Snow	AS610	Aspen Snow		
Pebble Ebony	PE814	Pebble Ebony	Supreme Cotton White	VC110	Supreme Cotton White		
Sanded Onyx	SO423	Sanded Onyx	Sanded Cornmeal	SC433	Sanded Cornmeal		
Tempest Dazzle	FD191	Tempest Dazzle	Sanded White Pepper	WP410	Sanded White Pepper		
Tempest Shimmer	FR148	Tempest Shimmer	Mosaic Dalmatian	QD212	Mosaic Dalmatian		
Tempest Starfire	FS198	Tempest Starfire	Pure White	SP016	Pure White		
Aspen Alder	AA625	Aspen Alder	Aspen Iceberg	AI612	Aspen Iceberg		
Aspen Glow	AG636	Aspen Glow	Tempest Polar	FP111	Tempest Polar		
Supreme	VN144	Supreme	Tempest Twilight	FT113	Tempest Twilight		
Natural Bridge		Natural Bridge	Supreme Ocean View	VO171	Supreme Ocean View		
Pebble Moon	PM832	Pebble Moon	Quarry Bluff	QB244	Quarry Bluff		
Tempest Coconut	FC112	Tempest Coconut	Tempest Whippoorwill	FW145	Tempest Whippoorwill		
Tempest Mystic	FM178	Tempest Mystic	Aspen Grey	AG620	Aspen Grey		
Tempest Peak	FP100	Tempest Peak	Pebble Grey	PG810	Pebble Grey		
			Sanded Mocha	SM453	Sanded Mocha		

1.3 Staron® Adhesive (continued)

Staron® Name	CODE	Adhesive Name	Sharing	Staron® Name	CODE	Adhesive Name	Sharing
Supreme Dandelion	VD175	Supreme Dandelion		Pebble Boulder	PB852	Pebble Boulder	
Pebble TeaRose	PT845	Pebble TeaRose	○	Pebble Chocolate	PC855	Pebble Chocolate	
Sanded Cornhusk	SC443	Sanded Cornhusk		Pebble Copper	PC851	Pebble Copper	
Sanded Oatmeal	SO446	Sanded Oatmeal		Pebble Seastar	PS843	Pebble Seastar	
Tempest Prairie	FP142	Tempest Prairie	○	Pebble Spinel	PS854	Pebble Spinel	
Tempest Rattan	FR124	Tempest Rattan		Placid	SP062	Placid	
Earthen Stratum	QL287	Earthen Stratum	○	Powder Blue	SP063	Powder Blue	
Sanded Dark Nebula	DN421	Sanded Dark Nebula		Quarry Minette	QM289	Quarry Minette	
Bright White	BW010	Bright White	○	Quasar White	SQ019	Quasar White	
Supreme Magnolia	VM143	Supreme Magnolia		Sanded Chestnut	SC457	Sanded Chestnut	
Crystal Pacific	NP932	Crystal Pacific	○	Sanded Clay	SC475	Sanded Clay	
Quarry Mesa	QM242	Quarry Mesa		Sanded Iceblue	SI462	Sanded Iceblue	
Metallic Sleeksilver	ES581	Metallic Sleeksilver	○	Sanded Meadow	SM465	Sanded Meadow	
Sanded Tundra	ST482	Sanded Tundra		Sanded Mint	SM463	Sanded Mint	
Quarry Stoneware	BS500	Quarry Stoneware	○	Sanded Papyrus	SP474	Sanded Papyrus	
Tempest Shallot	FS157	Tempest Shallot		Tempest Bronzestar	FB154	Tempest Bronzestar	
Tempest Caviar	FC188	Tempest Caviar	○	Sanded Taupe	ST486	Sanded Taupe	
Tempest Igneous	FI187	Tempest Igneous		Serene	SS023	Serene	
Tempest Blaze	FB147	Tempest Blaze	○	Ivory	SI040	Ivory	
Tempest Coffee Bean	FC158	Tempest Coffee Bean		Supreme Cloudbank	VC118	Supreme Cloudbank	
Quarry Starred	QS287	Quarry Starred	○	Supreme Delphi	VD111	Supreme Delphi	
Steel	ST023	Steel		Supreme Pastoral	VP177	Supreme Pastoral	
Aspen Cliff	AC652	Aspen Cliff		Supreme Presto	VP159	Supreme Presto	
Aspen Eggshell	AE642	Aspen Eggshell		Supreme Urban Grey	VU127	Supreme Urban Grey	
Aspen Lava	AL650	Aspen Lava		Sunflower(N)	SS042	Sunflower(N)	
Aspen Mine	AM633	Aspen Mine		Tempest Caraway	FC155	Tempest Caraway	
Aspen Pepper	AP640	Aspen Pepper		Tempest Genesis	FG174	Tempest Genesis	
Aspen Pond	AP665	Aspen Pond		Tempest Gold Leaf	FG196	Tempest Gold Leaf	
Aspen Sky	AS670	Aspen Sky		Tempest Spearmint	FS164	Tempest Spearmint	
Aspen Stucco	AS644	Aspen Stucco		Tempest Spice	FS137	Tempest Spice	
Bliss	SB022	Bliss		Tempest Zenith	FZ184	Tempest Zenith	
Blonde	SB043	Blonde		Univrs(N)	SU053	Univrs(N)	
Crystal Sundance	NS955	Crystal Sundance		Supreme Beige Granite	VB172	Supreme Beige Granite	
California Poppy(N)	SC052	California Poppy(N)		Aspen Concrete	AC629	Aspen Concrete	
Celadon	SC010	Celadon		Sanded Heron	SH428	Sanded Heron	
Cool Mint	SC063	Cool Mint		Dazzling White	SD001	Dazzling White	
Iris	SI056	Iris		Fog	SF020	Fog	
Metallic Galaxy	EG595	Metallic Galaxy					
Metallic Satingold	ES558	Metallic Satingold					
Mist	SM022	Mist					
Mosaic Nimbus	Qn287	Mosaic Nimbus					
Oasis	SO064	Oasis					
Pebble Blue	PB870	Pebble Blue					

2.1 Staron® Sheet Quality Inspection

The goal at Lotte Chemical Corp. Staron® is to provide the highest quality materials to our fabricators to ensure customer satisfaction. As a result, we check and recheck each individual sheet to meet our rigorous quality standards.

However, it is the fabricators' responsibility to conduct a visual inspection for defects and colour match for every sheet they work with.

TIP

After thorough inspection of the sheet, if you find any defect which will greatly increase your fabrication time, please contact your Staron® Distributor. Your Staron® Distributor will answer any question and provide assistance on Staron® Solid Surface Products. If you are unsure of the quality of the material, please contact your Staron® distributor for service.

Note

Lotte Chemical Corp. Staron® will replace materials which do not meet our product specification when delivered.

However Lotte Chemical Corp. Staron® replacement policy does not allow for any labour charges incurred during or after fabricating on the defective materials.

Table 2.1-A shows some of the standards set to help with the inspection upon receipt of Staron® Sheets (at the time of delivery).

Inspection Standards	Specification
Dimension	<div style="display: flex; justify-content: space-around;"> <div style="text-align: center;"> <p>[12 T]</p> <p>. Length: 3,680 ~ 3,690 mm, . Width: 760 ~ 763 mm, . Thickness : 11.75 ~ 12.25 mm</p> </div> <div style="text-align: center;"> <p>[6 T]</p> <p>. Length: 2,500 ~ 2,530 mm, . Width: 760 ~ 763 mm, . Thickness : 5.75 ~ 6.25 mm</p> </div> </div>
Broken / Cracked	None
colour Difference (Sheet to Sheet)	Lotte Chemical Corp. does not guarantee colour match. This characteristic is inherent with Solid Surface products in the industry. Checking for colour match before fabrication is not only required, but very highly recommended. Requirements on colour Match:
colour Difference (With same Sheet)	<ul style="list-style-type: none"> - Use sheets from same pallet - Check and use from same Lot # and stay with in specified range of sequence - Trial colour Match(Dry-fit test)
Length and Width Warping	Less than 1.6mm
Pinholes, Voids, Scratches	Any scratches, voids or pinholes should be removed by orbital sanding with 120 grit sandpaper for 3 minute/m ²
Foreign Particle White Spots	Solid colours: Over 0.8 mm diameter → None Other colours: Over 2.0 mm diameter → None
Tapered Edge	Less than 1.0 mm
Discoloration	None
Under side (Back side)	Sink mark: less than 2ea (Size: 100mm * 100mm), Over 1.5mm deep → None Pinholes: Over 6 mm diameter → None, Over 3mm deep → None

[2.1 - A]

Note

Before fabricate Staron special colours such as Supreme, Pearl particulate colours, Translucent colours, Mosaic series, Earthen series and Dark colours, please check technical bulletins as their characteristic may differ from normal Staron colours.

2.2 Staron® Sinks & Bowls Quality Inspection

Table 2.2-A shows some of the standards set to help with the inspection upon receipt of Staron® Shapes (at the time of delivery).

Inspection Standards	Specification
Broken / Cracked	Make sure to check for any cracks, especially around drain holes. Any chips or cracks will affect the integrity of the sinks and bowls.
colour Order	Check to see if the delivered goods are correct.
Correct Size	Remember, there are many sinks and bowls with similar designs. Measuring for correct size is recommended.
Accessory	Make sure all accessories are included in the package.
Correct Specification	Please check to see for correct dimension.
Structure uniformities	None
Foreign Particle	Less than 2
Pit Holes	Less than 2
Overflow	Check for correct location and placement.
Drain Holes	Check for correct location and dimension
Discolouration	None
colour Difference (Shape to Sheet)	colour match between shape and sheet is not guaranteed.

[2.2 - A]

➔ Note

Please inspect carefully upon receipt of the Staron® product. Lotte Chemical Corp. Staron® replacement policy does not allow for any labor charges incurred during or after fabrication on the defective materials.

3.1 Handling Staron® Sheets

Staron® Sheets are usually transported on pallets.

Staron® pallets should be unloaded with a forklift or other lifting device capable of handling following dimensions safely.

	Staron® Sheet	Empty Pallet	10 Staron® Sheets + Pallet
Weight (lbs)	121	55	1,265
Length (mm)	3680(145")	3708(146")	3708(146")
Width (mm)	762(30")	813(32")	813(32")
Height (mm)	12(1/2")	173(6 4/5")	300(11 4/5")



[1.1 - A]



[1.1 - B]

TIP

Forklift should have minimum of 6' forks.

If lifting device is not available, Staron® Sheets can be unloaded manually. However, it is very important to follow special procedures for your safety :

- Handle one sheet at a time
- Sheet should be handled on the edge
- Carry Vertically
- Always have heavy-duty protective gloves and proper safety shoes.
- Two people

TIP

Extreme temperatures will affect the product. Make sure to use caution when handling at a temperature below 40°F (4°C). For your safety, always use common sense and follow the safety guidelines when handling Staron® Sheets. Sheets should be carried one at a time on edge with one hand under to support and one hand for control.

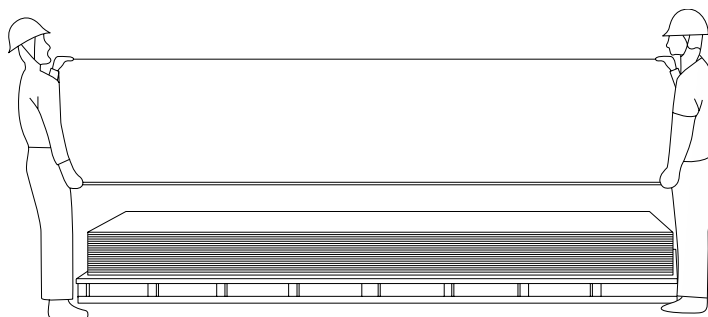

[1.1 - C]

3.2 Handling Staron® Sinks & Bowls

Staron® Sinks and Bowls should be handled carefully according to the instructions on the package. Although Staron® Sinks and Bowls are packaged to give maximum protection, it is important to use caution when handling them.

TIP

Staron® Sinks and Bowls should not be stacked more than 6 boxes high.

Remember! To reduce the chance of damage, do not drop, apply pressure, or place heavy loads on top.

3.3 Storing Staron® Sheets

There are two ways of storing Staron® Sheets to avoid warping or sagging.

Staron® Sheets are most effectively stored at temperatures between 59 ~ 73°F (15 ~ 23°C) and should be kept in a dry and well ventilated indoor area. Avoid exposure to moisture during storage.

- Staron® Sheets should be stored flat and evenly supported as illustrated in (Figure 1.3 - A).

Note

Staron® Sheets should be stored for easy access where Lot Numbers and colours can be identified.

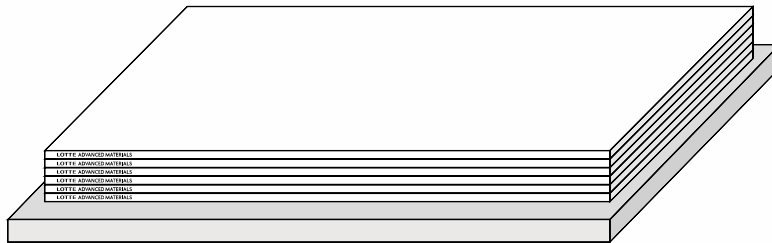

[1.3 - A]

TIP

Special care should be taken in storing Staron® Sheets to prevent them from warping and sagging.

Storage system, which allows easy accessibility, handling, and Lot identification, are the key.

Exposure to moisture and direct sunlight during storage may damage the sheets.

Staron® Sheets should not be allowed to be stored in a wet environment.

3. 4 Storing Staron[®] Sinks & Bowls

Staron[®] Sinks and Bowls should be handled carefully according to the instructions on the package. Although Staron[®] Sinks and Bowls are packaged to give maximum protection, it is important to use caution when handling them.

■ **TIP**

Staron[®] Sinks and Bowls should not be stacked more than 6 boxes high.

Remember! To reduce the chance of damage, do not drop, apply pressure, or place heavy loads.



[1.4 - A]

4.1 Basic Fabrication Shop

Similar to other industries, Staron® Fabricators vary on the brand of tools they like and use in their shops.

The following are the recommended tools to be used on Staron® 100% Acrylic Solid Surface materials.

It is up to the fabricator to choose the brand of tools to fit their needs.

However, it is very important to follow the guidelines on fabrication methods and tools that are not recommended or prohibited.

4.2 Tools Check List

- Router
 - Trim Router
 - 38mm(1½) H.P. Router
 - 83mm(3¼) H.P. Router
- Hole Saw Kit
 - 29mm(1⅛"), 32mm(1¼"), 35mm(1⅜"), 38mm(1½")
- Drill
- Hot Glue Gun
- Glue Stick
- Straight Edge
- Sander
 - 152mm(6") with vacuum
 - Stiff pad and contour pad
- Jig Saw (For making Templates only, Do Not use on Staron®)
- Adhesive Gun
- Circular Saw
- Belt Sander
- Grinder
- Bar Clamps
 - 305mm(12")x 102mm(4") throat
- 51mm(2") Spring Clamps
 - 200 to start (4 for every foot of edge buildup)
 - Daniclamps - PVC pipe type (4 for every foot of edge buildup)
- 102mm(4") Spring Clamps
 - For seams (depending on seaming method)
- Carpenters Square
- 102mm(4") Drywall Square
- 3mm(⅛") Luan or Cardboard for Templates
- Caulk Gun
- Spray Bottle
- Denatured Alcohol
- Vacuum
- Aluminum Tape - For Cook tops and Slide in Ranges
- Micron Sand Paper - 100, 80, 60, 30
- Scotch Brite™ - (Maroon and Grey)
- 31/32 AC Fir Plywood - Buildup Strips

- Silicone
 - Clear for general purpose
 - Coloured for splashes
- Router Bit
 - Bowl Bit
 - 51mm(2") Straight Bit
 - 19mm(¾") x 51mm(2") Template Bit - (Top Bearing)
- Various Decorative Router Bits for Edge Details
- Table Saw
- Coved Splash Kit
 - 10mm(¾") Cove Bit
 - 22mm(7/8") ~ 25mm(1") Straight Bit
 - Router Guide
 - Bar Clamp - 2 for every 152mm(6") of Back Splash
 - Daniclamps - 2 for every 152mm(6") of Back Splash
- Seaming Tools
 - Depending on the Method you choose
- Additional Tools
 - Depending on the need, more Router, Sanders, Panel Saw,
 - CNC machine, Shaper, V-Groove machine...

Router

Task	Minimum Power	Tool/Bit
Trim Router	N/A	Carbide tipped trim router bits
General purpose work : e.g. edge and seam trimming, cutouts	1 ½ Hp (1.1 kw)	12mm (½")carbide tripped single flute with 12mm (½") shank
Heavy duty work: e.g. bulk cutouts, banjo cuts, coving	3 Hp (2.3 kw)	10mm (¾")carbide tripped double flute with 12mm (½") shank
Revolution per minute (rpm) : 10,000 ~ 28,000		

[4.2 - A]

TIP

The recommendations above are based on maximising maintenance on routers and quality tungsten tipped bits in day-to-day operations

Saws

Blade diameter (mm/inch)	No. of teeth	Plate (mm/inch)	Task (mm/inch)
200/8	64	2.2/0.09	2.8/0.11
250/10	80	2.6/0.10	3.2/0.13
300/12	96	2.6/0.10	3.2/0.13
350/14	108	3.0/0.12	3.6/0.14
400/16	120	3.6/0.14	4.4/0.17
450/18	144	3.6/0.14	4.4/0.17
500/20	160	3.6/0.14	4.4/0.17

[4.2 - B]

Regardless of the type of saw, all saws must :

1. Be heavy duty
2. Have triple-chip blades of tungsten carbide
3. Have hook angle blades with pitch of -5 to 10 degrees and be described as "for cutting hard plastics"
4. Have 4,000 ~ 6,000 rpm
5. Have a quiet blade, small gullets, brass plugs and heavier blade stock
6. Be used for cutting a straight line

Blades must be sharpened regularly with a 400 ~ 600 grit (20 ~ 40 micron) grinding wheel.

Blades must have 8 teeth per diameter inch (25mm diameter) and are recommended for Solid Surface.

5.1 Site Inspection

Before installing Staron®, it is very important to make sure all relevant site details are checked and verified.

Overview

1. Inspect the surroundings from parking space to installation site.
 - accessibility from the parking lot to the front door
 - check for the distance and other obstacles
 - entrance size
 - wall condition
 - ceiling height
 - cabinet condition
 - electrical and plumbing positioning
 - make note of any other information which will help to minimise problems during fabrication and installation of Staron® Countertop
2. Relationship between you and your customer.
 - Code of Conduct
 - professionalism
 - detailed instructions on what they need to have completed before the installation date
 - inform consumers on what they should expect and what you will do to minimise the noise, dust, and other impacts

Provide friendly consumer service, treating all consumers with service oriented attitudes, courtesy, and respect at all time.

- On-time Scheduling.
 - Provide accurate scheduling.
 - Arrive on the day and time as promised.
 - In case of delay or cancellation, notify the consumer before the scheduled appointment.
- Provide professional image at all time, maintaining appropriate dress code.
- Do not smoke during service call.
- Do not be under the influence of drugs or alcohol during service call.
- Do not use drugs or alcohol during service call.
- Do not play radios or any other listening devices during service call.
- Do not take lunch break on service call premises.
- Do not use inappropriate language during service call.
- Keep the working area clean from beginning to the end, cleaning up all debris and dust during and after the installation.
 - Take all necessary precaution to protect the premises from dust and debris
- Please be sensitive to the consumer's concern.
 - Providing them the necessary information and explanation of the job.
 - All work should be discussed and agreed upon prior to the installation.
- Provide instructional materials and verbal instructions to the consumer on proper care and maintenance of the Staron® products.

5.2 Levelling

Prior to installing Staron® Countertops, make sure that all the cabinets are levelled.

Levelling and clearing all debris from the cabinets is very important in preventing future crack(s) to the Staron® Countertops.

Overview

Step 1 : Make sure cabinets are all on the same plane.

- Up to 3mm($\frac{1}{8}$ ") difference in the plane can be corrected by shimming the Cabinets straight.
- If there is more than an 3mm($\frac{1}{8}$ ") gap between the cabinets, they need to be reset.

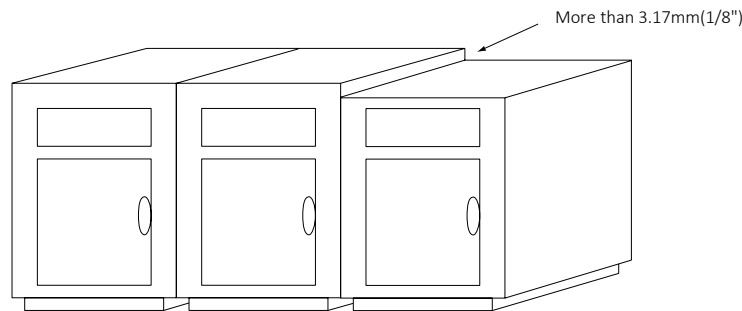

[5.2 - A]

TIP

Have the contractor or cabinet installer reset the cabinets. Remember, if something should happen while you are resetting the cabinets, you will be held responsible if any damage occurs.

Step 2 : Make sure all cabinet frames are clean and clear of all obstacles.

Old Cabinets - make sure all the old glue is completely cleaned from the top of the cabinets.

New Cabinets - Make sure all the staples, screws, brads and other obstacles are either pulled out or at least flush with the top of the cabinets.

Step 3 : All cabinets and end panels should be secured to the wall or the floor.

Make sure that no movement will occur. Any movement will cause stress in the Staron® Countertop.

TIP

Moving Blanket

Take some moving blankets to the Jobsite. Spread the blankets out from the entrance to the installation site. Make sure that your shoes or your tools don't touch the customers floor or cabinets. Your customers will appreciate your effort and you will gain their confidence and trust.

5.3 Required Tools

Having proper tools will save time and insure quality workmanship

- Level, 50mm(2"), 102mm(4"), and 152mm(6")
- Chisel
- Hammer
- Screwdriver
- Straight edge 152mm(6") ~ 203mm(8")

Introduction

Before any fabrication of Staron®, make accurate templates that are true representation of the top. This will help to insure problem free fit during installation.

Templating is a vital part of the fabrication process.

If your templates are perfect and top is fabricated according to the templates, the installation will be problem free.

There are many different ways of making the templates, it is up to you to choose the one that best suits your business.

1. Measurement Templates
2. Luann Strip Templates
3. Cardboard Templates
4. Digital Templates

6.1 Measurement Templates

This method is used most often by Fabricators.

However, this method takes the longest time.

You need to spend more time and take more accurate measurements to make sure the top fits with minimal fitting on the jobsite.

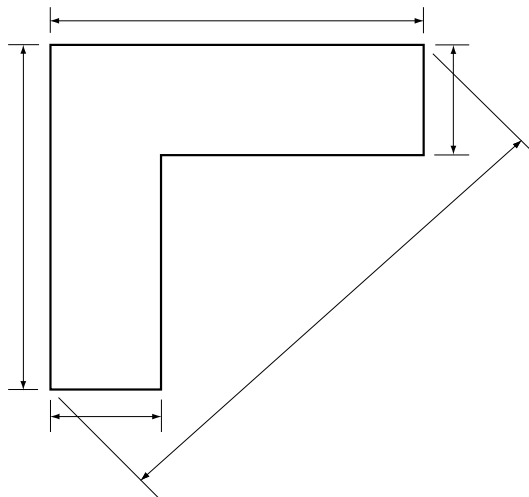

[6.1 - A]

6.2 Luann Strip Templates

3mm($\frac{1}{8}$ ") Luann is ripped to specific width depending on the overhang you desire.

Example :

- 32mm($1\frac{1}{4}$ ") overhang
 - cut the strip to 50.8mm(2") wide
 - 51mm(2") strip = 32mm($1\frac{1}{4}$ ") overhang + 19mm($\frac{3}{4}$ ") cabinet frame
- 38mm($1\frac{1}{2}$ ") overhang
 - cut the strip to 57.15mm($2\frac{1}{4}$ ") wide
 - 57mm($2\frac{1}{4}$ ") strip = 38mm($1\frac{1}{2}$ ") overhang + 19mm($\frac{3}{4}$ ") cabinet frame

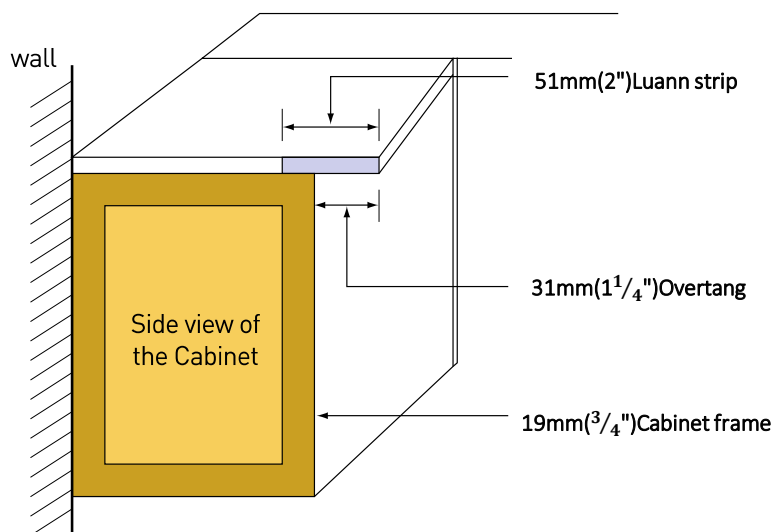

[6.2 - A]

Some people will make the template flush with the front of the cabinet and add the overhang later. As you create your templates, choose the method you are most comfortable with.

1. Make sure you have enough template material on hand.
2. Plug in your hot glue gun.
3. Start laying out your strips on the cabinets as illustrated in the drawing (6.2-B)

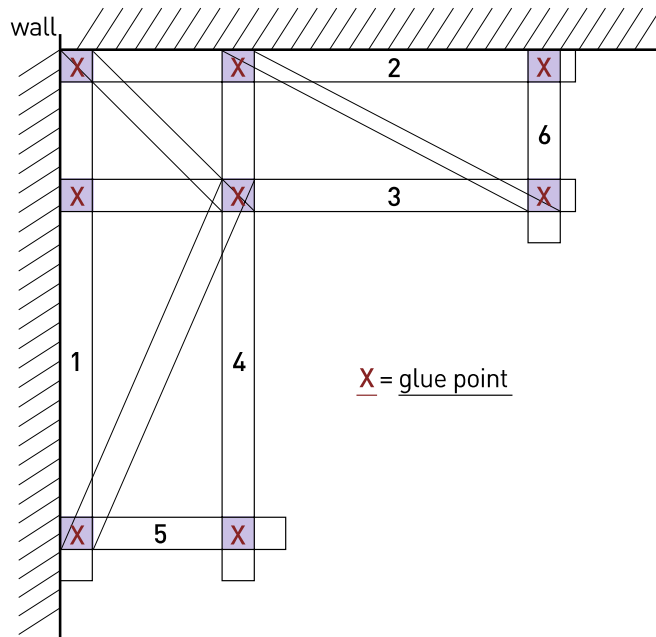

[6.2 - B]

Overview

- When the glue gun is hot, start gluing the wood pieces together.
- Do not bend the stick 1 and 2 tight to the wall, "let it float".
- Glue the sticks 3, 4, 5, and 6 tight against the wall.
- The sticks should be tight against the corner, where 1 and 2 meet.
- The points where 3, 4, 5, and 6 touch the wall will become your scribe points.
- Don't forget to mark the centres of your sink base on the templates.
- Mark the centre of the cooktop or any other cutouts.
- Set sticks 3, 4, 5, and 6 flush with backside of the cabinet frame for exact overhang.

6.3 Cardboard Templates

Tips on why cardboard templates are good to use : (fits into small vehicle, use it as a cover, write customer info right on the template, doesn't fold easily.

Overview

- Place the cardboard on the cabinets as illustrated in the drawing. (6.3-A)
Overlap the pieces (overlap by 203mm(8") – 254mm(10")).
Hot glue the pieces together.

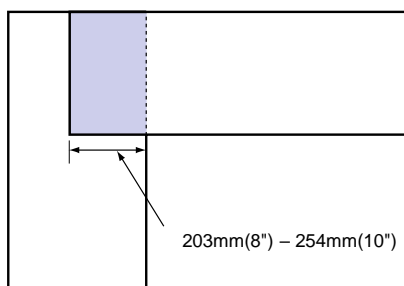

[6.3 - A]

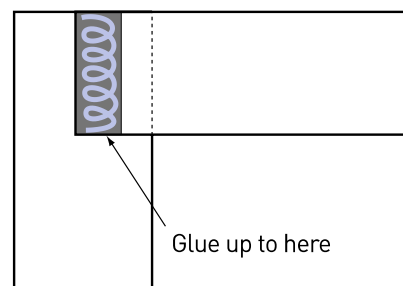

[6.3 - B]

- When you get the cardboard to cover the cabinets, take your strips of cardboard (38.1mm wide strips) and glue them to form the frame as illustrated in the drawing (6.3-C)

These strips will give you exact measurements for scribing to the wall.

If you scribe the template to the walls, you can pre-scribe the top in the shop. Making the installation go faster.

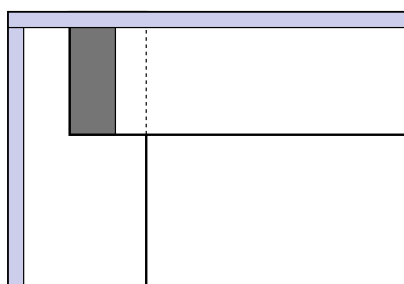

[6.3 - C]

- When the template is finished, trace the front edge of the cabinets to calculate and add the overhang.
Calculate the overhang you want and cut down to size.
Remember to mark all centre lines of the cutouts (sinks, cooktops, etc.).

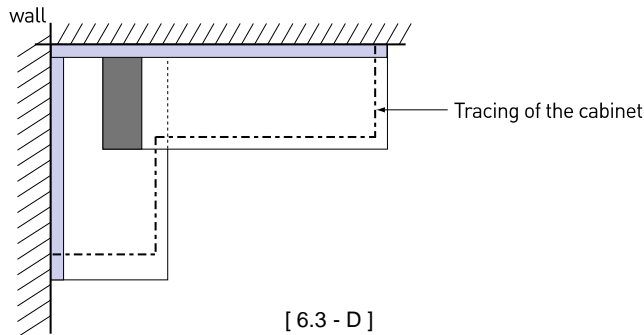

TIP
DO NOT FOLD THE CARDBOARD

Cardboard templates will show the customers the actual size of the top and give them the opportunity to change the size of the overhang or other features. Mark all the necessary information right on the template for easy access.
Cardboard templates can be used after the installation is completed to protect the countertop by taping it to the top. This will help protect against other trades such as painters, electrician, plumbers, etc from accidentally damaging the top. Remember, in many instances, you will be held responsible for the damage caused by other trades coming in after you. Protect your work by informing the customer and whatever barrier you can supply (cardboard template is a good start).

4. Cutting the template

In some instances, the template will be too big to fit in your vehicle.

Note
It is not recommended to cut templates, the integrity of the template structure will be voided.

The preferred method with card board templates. :

- If you have to cut apart the template to be able to fit it in your vehicle, cut it at one of your overlays (only through the top layer).
Illustrated in the drawing (6.3-E and 6.3-F)
- Afterwards, you can glue the template back together, where it will line up exactly.

TIP
DO NOT FOLD CARDBOARD!

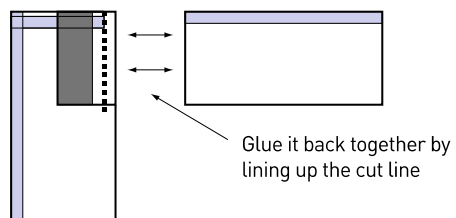
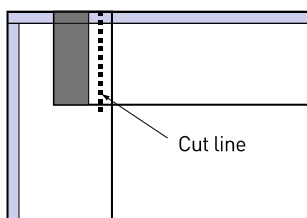

6.4 Digital Templates

With the advancement of technology, there are many different variety of equipments and programs to help with your templating needs. Please contact your Digital Template manufacturers for further information and instructions..

6.5 Tools Needed

- Hot glue gun
- Glue Stick
- Utility Knife
- Tape Measure
- Straight Edge
- Level 51mm(2'), 102mm(4'), 152mm(6')
- Paper and Pencil
- Magic Marker
- Template Material (depending on the templating method)
 - Luann
 - Cardboard
 - Digital Template Equipment

7.1 Planning

Careful planning is the key factor to a successful job.

When planning a job, having the right seam placement will help you minimise the use of material and time.

Remember, saving of material and time will help your business be competitive in the market.

In addition, the correct seam placement will help to insure that your customers to enjoy the beauty of Staron® Countertop without problems for years to come.

7.2 Positioning

All seams need to be at least 76.2mm(3") from sink cutout.

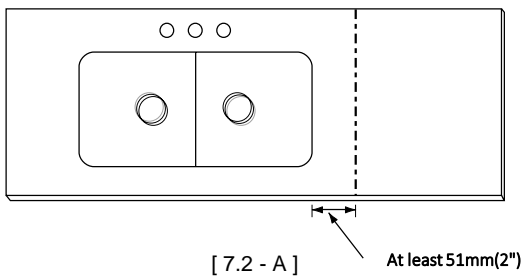

All seams need to be at least 76mm(3") from any cutout.

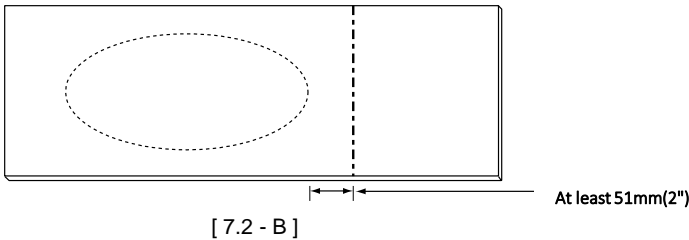

NO SEAMS THROUGH A COOKTOP!

Under no circumstances, should a seam go through a cooktop cutout.

If the kitchen is designed where there is no other choice, please contact Staron® Technical Service for advice.

All seams need to be at least 25mm(1") past the radius of an inside corner. Seams are potential weak point where crack(s) can start. Seams that are located further away from the corner can better prevent crack(s).

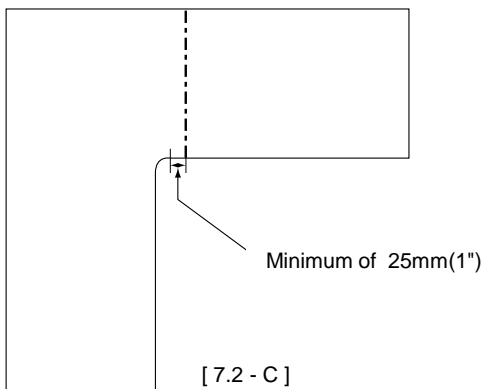

There should be no seams in an overhang on a peninsula or island.

Seams perpendicular to the overhang are allowed.

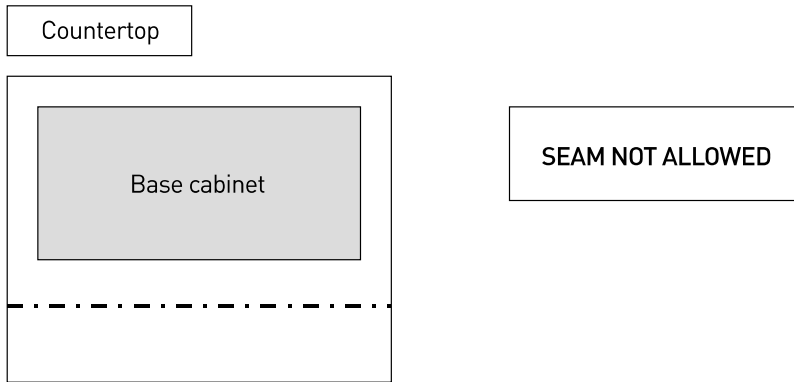

[7.2 - D]

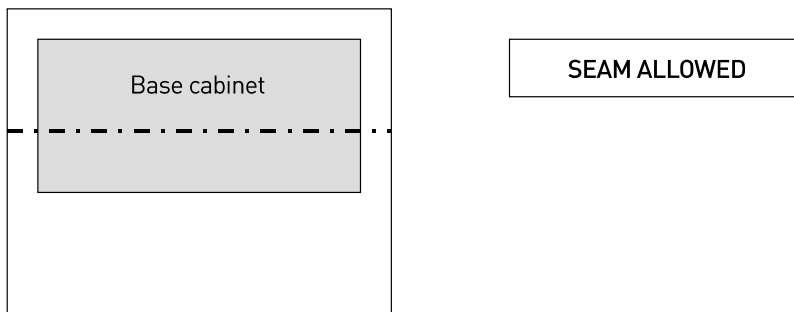

[7.2 - E]

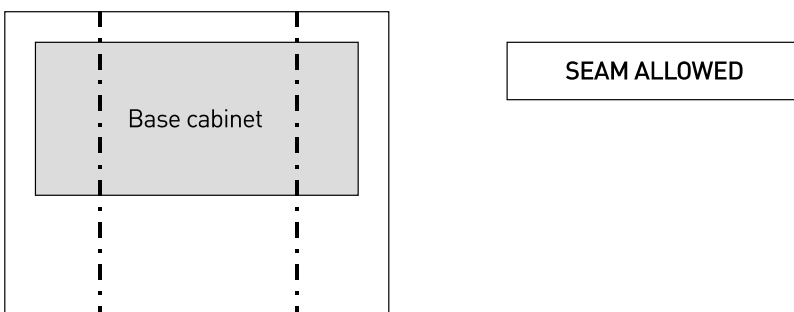

[7.2 - F]

On rare occasions, you will have a job seam going over a dishwasher.

You will need to support it from cabinet to cabinet with plywood.

Make sure to notch out plywood to accept seam plate.

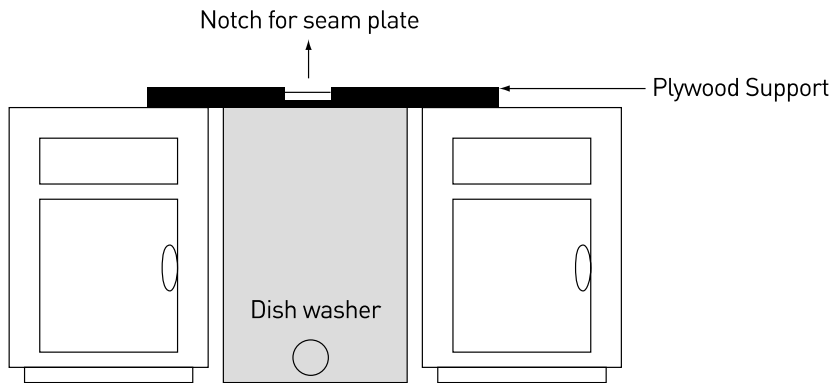

[7.2 - G]

Seams are not allowed through sink cutouts.

On rare occasions, there is no other choice but to seam on a splay corner with sinks.

Please consult with Staron® Technical Services before proceeding.

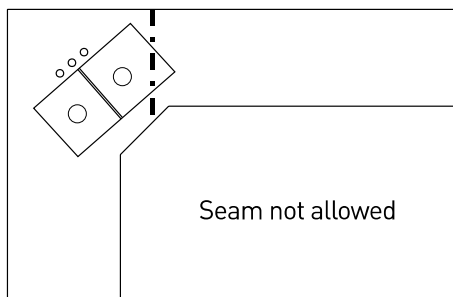

[7.2 - H]

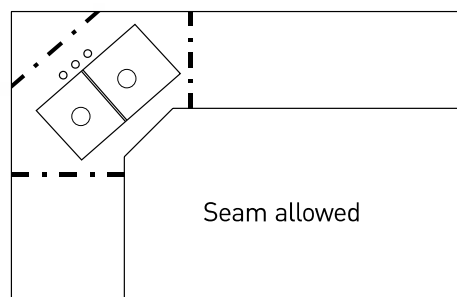

[7.2 - I]

8.1 Tools Needed

The following tools must NOT be used to cut Staron® at any time :

- Jig Saw
- Hacksaw
- Non Solid Surface Saw Blades
- Auger Bits

Recommended Tools

- Circular saw with Carbide or Diamond Blades
- Table Saw (with out-feed table)
 - 3 HP minimum
- Panel Saw
 - 5 HP (recommended)
 - Cabinet Saw or Stationary Saw (recommended)
- Routers (3HP minimum)
- Bar Clamps, "C" Clamps
- 12mm(½") Straight Bit (Carbide tipped)

8.2 Overview

When cutting Staron®, make sure the piece is totally supported.

When using a Circular saw, you will be rough cutting only. Always use a router and straight edge for final cuts.

Jigsaws should never be used to cut Staron® solid surface.

When using a router, always run the router left to right (clockwise).

All inside corners should have a minimum of 12mm(½") radius.

Remember, the bigger the radius the better.

Radius larger than 12mm(½") should be done with a template.

➔ Note

All inside corners should have at least ½" radius. This includes all cutouts. Square corners will not be covered under warranty. Any 90 degree inside corner is a stress point, and will crack eventually.

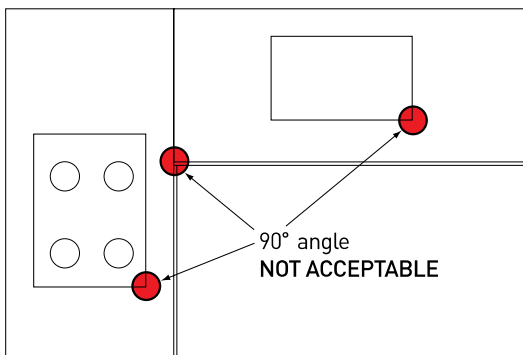

[8.2 - A]

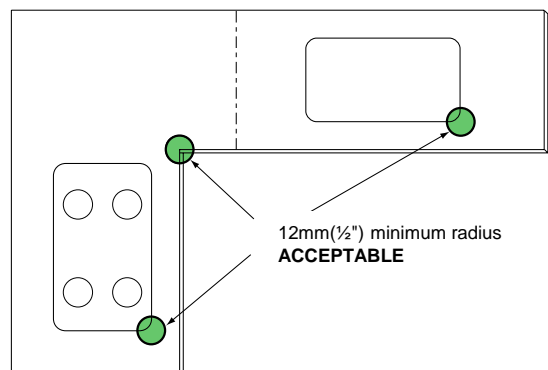

[8.2 - B]

9.1 Tools Needed

- Router : 3 1/4HP
- 12mm(1/2") x 38mm(1 1/2") double flute bit
- Straight edge
- Clamps
- Denatured alcohol
- Clean Rags
- Clamping Method
- Release paper or Scotch tape
- Ski router
- Sander
- Vacuum
- Sandpaper : 80 grit
- Panel Saw (Optional)
- Table Saw (For rough cuts)

Introduction

When planning any fabrication and installation of Staron®, seams should be planned in a manner which minimises the use of materials and maximize product performance. Before putting seam adhesive between the two pieces to be seamed together, you need to machine the two pieces to match.

There are 3 ways to cut seams

- 1) Wavy edge bit
- 2) Straight cut using Panel Saw
- 3) Mirror cut

9.2 Wavy Edge Bit

1. This bit has a slight wave to it. It requires a special router base.

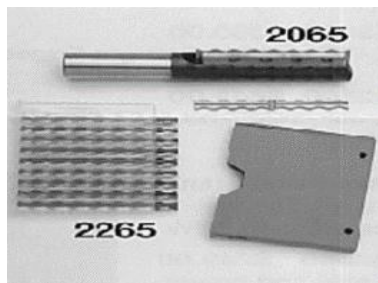

[9.2 - A]

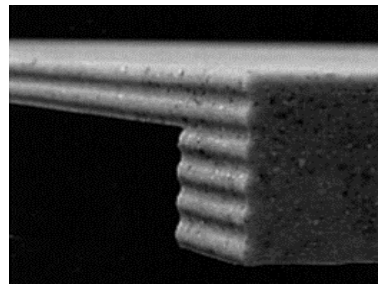

[9.2 - B]

2. Cut one piece with one side of the base.
3. Then, cut the other piece with the 2nd side of the base.
4. This offsets the "wave" of the router bit by 12mm(1/2").
5. Set up your straight edge back the amount of the router base.
6. Run the router from left to right.
7. By cutting your seams using this type of bit, you are allowing 50% more seam area.

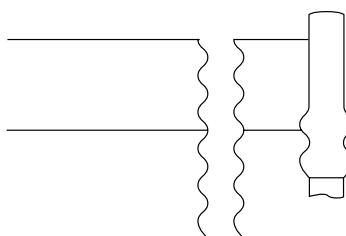

[9.2 - C]

9.3 Straight Cut

1. This method requires Panel Saw with Solid Surface Blade or CNC Router.
2. Remember, you should never use following tools as your final cut before seaming.
 - Table saw
 - Circular saw
 - Straight edge router
 - Or any other cutting method except Panel Saw, CNC Machine, or Wavy Edge.



[9.3 - A]



[9.3 - B]

9.4 Mirror Cut

1. Most effective method of getting a good seam when expensive machines such as Panel saw or CNC are not available, is to use a method called the "MIRROR CUT".
2. With this method, you will cut both pieces to be seamed at the same time.
3. This will make the two pieces match up perfectly "mirror" to each other.

Procedures:

1. Take the 2 pieces to be seamed together and set them 10mm($\frac{3}{8}$ ") apart, making sure that the 2 pieces are parallel to each other.

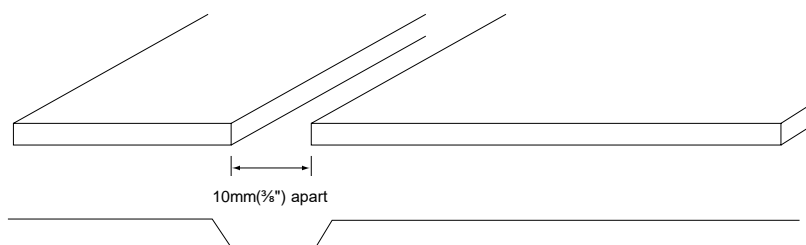

[9.4 - A]

➔ **Note**

You may want to make a "Jig" to make sure that the 2 pieces are exactly 9.5mm($\frac{3}{8}$ ") apart throughout the seam line. This "Jig" could be made from a piece of Staron® or any other materials that will keep its form.

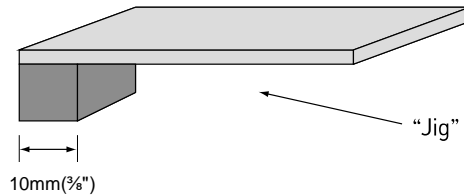

[9.4 - B]

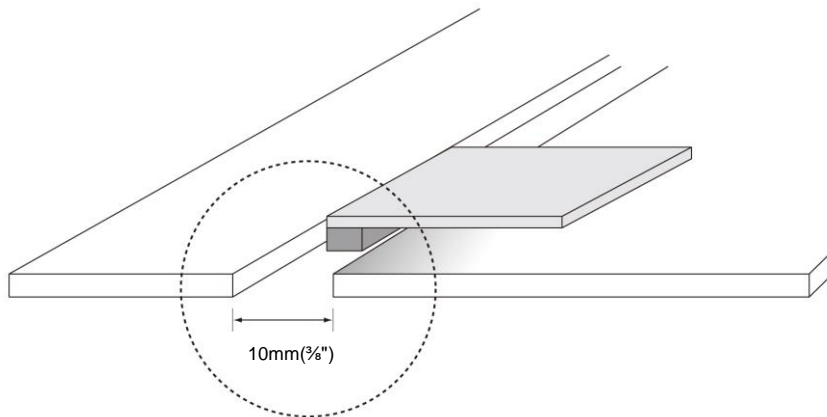

[9.4 - C]

2. After making sure that the 2 pieces are exactly 10mm($\frac{3}{8}$ ") apart and parallel to each other, use a 12mm($\frac{1}{2}$ ") bit and a router to cut.
3. Set up your straight edge on the left side of the 2 pieces being cut.
4. Measure the distance from the edge of the router bit to the edge of the router base + 2mm($\frac{1}{16}$ ").
5. Set the straight edge on the left side, back the same distance you just measured.
6. Set the depth of the router bit to go through the material.
7. Run the router from left to right.

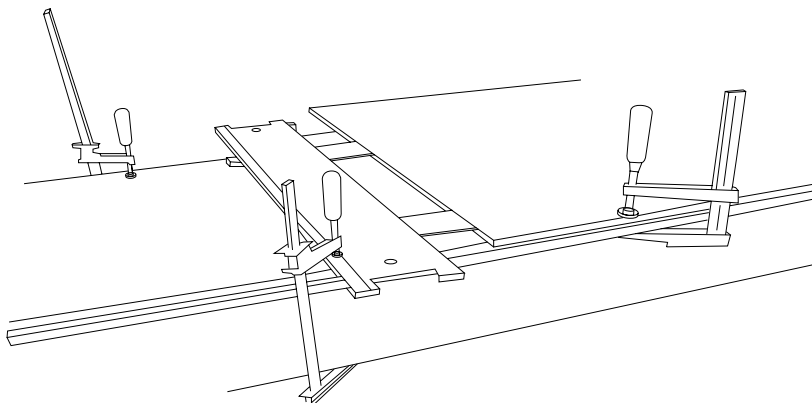

[9.4 - D]

SN-804-2020

TIP

Make sure the cord does not get caught on a clamp or table.

Once you start the cut, **DO NOT STOP!**

Make sure to clamp all the pieces so they do not move.

When using a Mirror Cut to cut your seam, make sure to have the 2 pieces **FLAT**.

If your pieces are not flat, the seam will open up, resulting in a bad (visible) seam.

If the 2 pieces are flat when cutting, your seam should turn out perfect.

The seam line should disappear if your cut is perfect when you dry-fit the 2 pieces.

Remember, if you see a seam line when you dry-fit the 2 pieces, you will see the line after you glue them. Re-Cut the pieces before proceeding.

Note

If the seam disappears without seam adhesive, then your seam will disappear with seam adhesive as well.

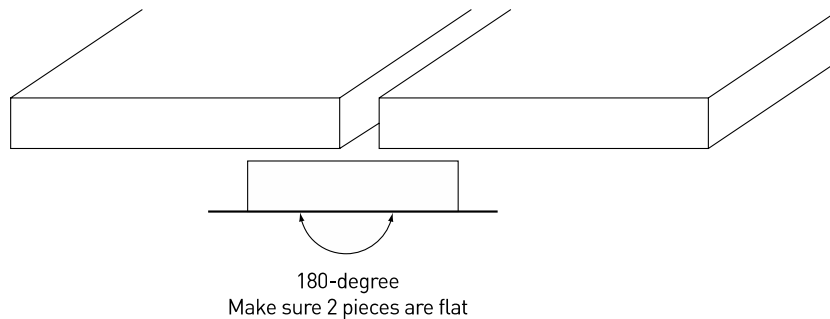

[9.4 - E]

9.5 Edge Preparation

After seams are cut, using one of the methods listed above, you will be ready to apply seam adhesive.

However, before applying seam adhesive, good edge preparations are necessary by removing and following procedures below.

Procedures :

- Abrade or sand the edge of the material, make sure not to round off the edge you just cut.
- You need to use 150 grit (100 micron) or equivalent sandpaper.
- All you need to do is to go over the edge 2 to 3 times.
- Abrade everything but the top 2mm(1/16"). Abrading the whole edge will round the top you've just cut.

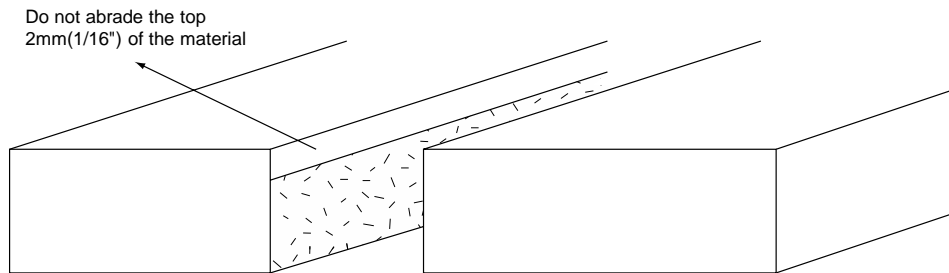

[9.5 - A]

TIP

Abrade by hand. You could round off the top edge with a sanding block.

If you round off the top edge, your seam will show when finished.

9.6 Seam Adhesive

1. After Seam preparation is completed, you are now ready to apply the adhesive.
2. Place some sort of release paper (red rosin or craft paper) under the seam.
Without a release paper under the seam, the seam adhesive will glue the top to the table.
3. Release paper can be anything from wax paper to Scotch Tape®.
4. 2" wide Scotch Tape® seems to be enough, however, it is advisable to place another layer side by side to just in case the top moves.

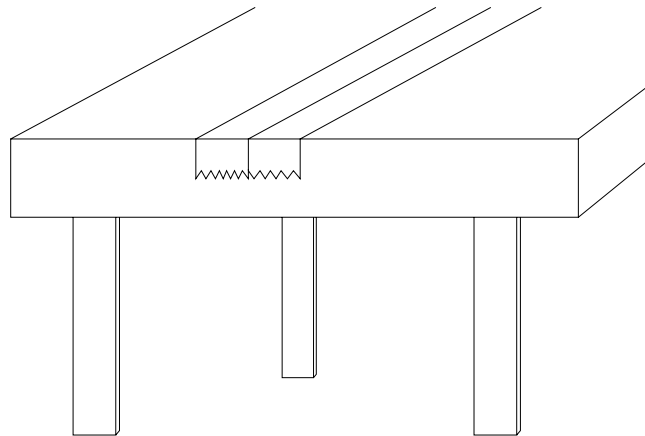

[9.6 - A]

5. Wipe the 2 seam pieces down with denatured alcohol.
6. Remember to wipe in one direction. This way, you will not contaminate the area you just wiped.
7. Remember, once you wipe the material down, do not touch the pieces.
The seam adhesive could pick up the oils from your skin and discolour the seam. This happens most commonly on the light colour materials.
8. Decide what kind of clamping method you will use to clamp the two pieces to be seamed. There are several ways to clamp the pieces together.
 - A. Wood block and clamps
 - B. Suction cups and clamps
 - C. Paralign or similar clamping system



[9.6 - B]



[9.6 - C]



[9.6 - D]

9. Once you decide on a clamping method, the seam adhesive can be applied.
10. Pull the 2 seam pieces apart about 3mm($\frac{1}{8}$ ").



[9.6 - E]



[9.6 - F]



[9.6 - G]

➔ **Note**

The sheets need to be flat before seaming. The flatter the sheets are, the easier the sanding will be when the seam adhesive is fully cured. If the sheets are not flat, they will need to be shimmed up. Remember, this needs to be done before applying seam adhesive.

11. Before placing the mixing tip on the adhesive cartridge, make sure to purge (squeeze) a small amount of seam adhesive out, to ensure both Adhesive and Activator are dispensing properly. Place the mixing tip and tighten with (locking nut) and once again purge (squeeze) the trigger twice to make sure you have good mixing at the tip.
12. After the seam adhesive is ready, start at one end and fill the 12mm($\frac{1}{2}$ ") gap. It should be about full. Do not leave any air holes or lapses in the adhesive. If there are any air holes or lapses, go over the entire seam again with second bead.



[9.6 - H]

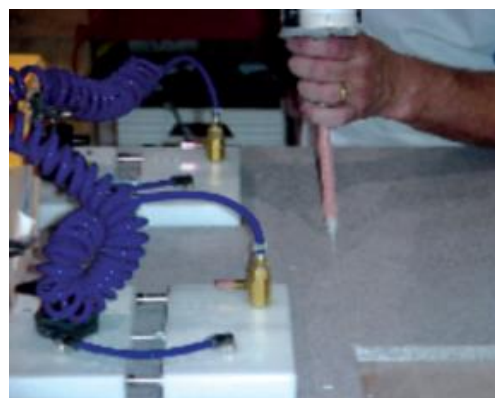

[9.6 - I]

➔ **Note**

It is easier to start at the furthest point of the seam and pull the seam adhesive toward you.

13. Once the seam adhesive is placed in the seam, the 2 pieces can be pulled together with whatever method of clamping you have chosen.
14. Let the seam adhesive dry until it is as hard as the sheets themselves.
This usually takes approximately 45-60 minutes, depending on the air temperature and sheet temperature. The seam will dry faster when it is warmer and take longer when the temperature is cooler.
15. The width of adhesive seaming line should not exceed 0.12mm



[9.6 - J]



[9.6 - K]



[9.6 - L]

➔ Note

Once the seam adhesive is fully cured, it can be sanded down.

The seam adhesive is cured when it is no longer wet. It should be hard to the touch.

Some of the seam adhesive will squeeze out when the sheets are pulled together. They could be easily removed using a Ski-Router or a sander. Do not apply too much pressure to the seam as this may squeeze all the adhesive out, thus weakening the seam.

9.7 Ski Routing and Sanding

Once the seam adhesive has fully cured, it can be taken down using a Ski router.

Ski routers can be purchased or made, using a router with 12mm(½") bit and a ski (piece of wood or Staron® material) attached to the base of the router.



[9.7 - A]



[9.7 - B]

1. Set the bit flush with the top.
2. Run the ski router over the cured seam adhesive and route off any excess seam material.
3. Once the excess seam material is routed off, you can finish up by sanding the area. Sand it with 150 grit (100 micron) sandpaper. Do not stay in one area too long while sanding. This will create a valley on the top. Remember to keep the sander moving at all time.
4. When the sanding is finished, an area of about 457mm(18")~ 508mm(20") should have been sanded, This will help feather out the seam area.

➔ **Note**

Never remove excess adhesive with a belt sander as this will overheat the seam causing possible weakness, discolouration or failure.

▶ **TIP**

Spray the seam area with water and look at the seam. It is at this point, you need to decide if the seam is acceptable or needs to be redone. If the seam needs to be redone, it is better to do it now, rather than after all the work is done. This will save you time and material in the long run.

9.8 Seam Plate

After the seams are sanded, seam plates need to be seamed on.

A seam plate is a 102mm(4") wide piece of Staron® material with 45° angle cut on both sides.

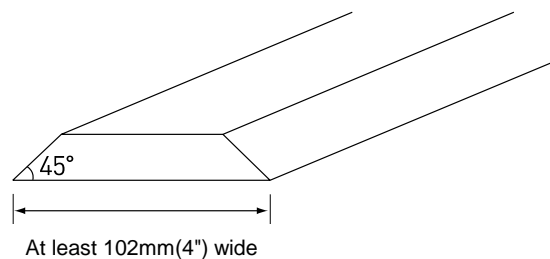

[9.8 - A]

➔ **Note**

Remember, 90 seam plate is a stress riser.
Seam plates should be cut to 45° angle.

When seaming on a seam plate, there are several steps that need to be taken.

1. Make sure the seam plate does not rock. Seam plate should sit flat on the top.
2. Cut the seam plate from the back of the front buildup to the rear of the top.
There shouldn't be any gap between the front edge buildup and the seam plate.
3. Abrade both the seam plate and the top where they will be glued together.
4. Centre the seam plate over the seam. There should be 51mm(2") on both sides of the seam. Trace out the seam plate.
Clean with denatured alcohol.
5. Place the seam adhesive on the top where the seam plate was traced out.
Apply seam adhesive on all the perimeters and every 19mm(¾") to fill in the traced out area.

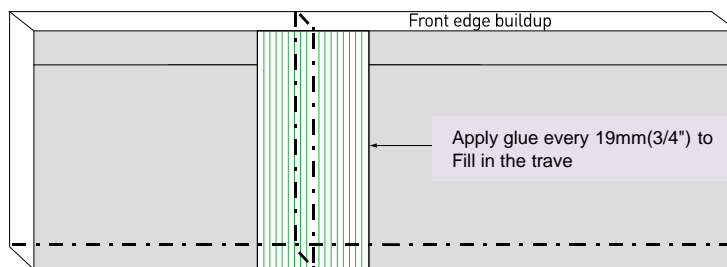

[9.8 - B]

TIP

This will give an adequate amount of seam adhesive to give 100% coverage.

6. Place the seam adhesive between the seam plate and the front edge buildup.
This will make the top, seam plate, and the front edge buildup become one piece.
7. Clamp the seam plate to the top. When the seam plate is clamped, the seam adhesive will spread to give 100% glue coverage.

Note

Seam adhesive should bead up along the outside edge of the seam plate.
Do not scrape off the excess. This adds strength to the plate and the top.

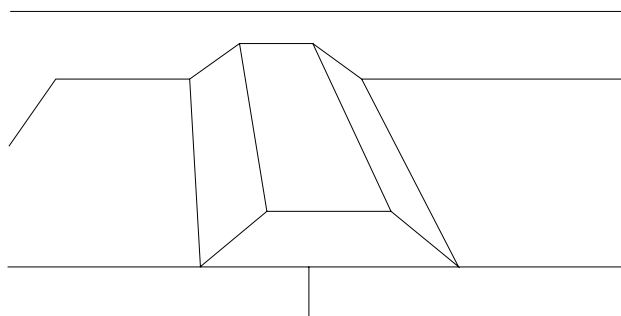

[9.8 - C]

In fabricating a Staron® Countertop, you have the option to give the customer a unique edge treatment, which will look great and make the people love their Staron® Countertops.

There are three effective ways to buildup the edges for Staron® Countertops.

- Stacked Edge
- Drop Edge
- V-Grooving

10.1 Stacked Edge

Stacked Edge Buildups

Stacked Edge buildup is a deck with 2 layers of 12mm($\frac{1}{2}$ ") material stacked on top of each other. (Illustrated in 10.1-A)
With this method, in addition to building up the edges, decorative inlay stripes can be accomplished very easily.

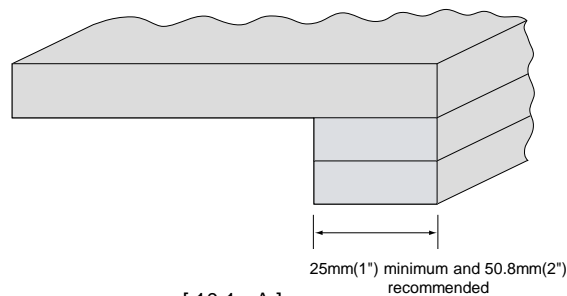

When applying seam adhesive to the deck, place seam adhesive on back edge, front edge, middle where the stacked edge is being place.

Apply double 6mm($\frac{1}{4}$ ") bead of adhesive to the top of each other.

Place wood blocks every 305mm(12") behind the build up to keep the build up from sliding back once the adhesive is applied. Hot glue these blocks down at 45° angle on the deck. This will make it easy to remove them later, when all the buildups are seamed on

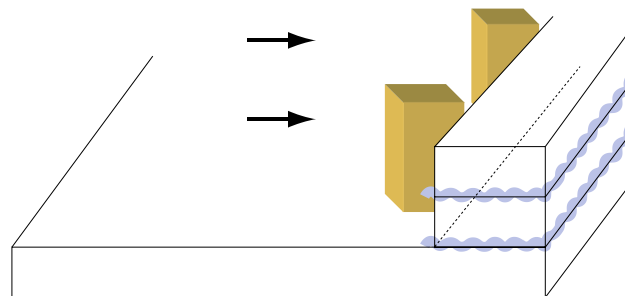

TIP

With accent strips, use the colour seam adhesive that matches the strip being put in the top.

Wood blocks can be made from any wood.

10mm($\frac{3}{8}$ ") MDF seems to be the best choice.

MDF is easy to remove when the buildups and other tasks are finished.

Clamp the edge buildup with 51mm(2") spring clamps or Dani clamps every 51mm(2") ~ 76mm(3"). This will give just enough clamping pressure to make the seams inconspicuous.

➔ **Note**

Too much clamping can cause all the seam adhesive to be squeezed out.

This is called "Starving the Seam". If you starve the seam, there is a good chance of seam failure during the life of the countertop due to lack of seam adhesive holding the materials together.

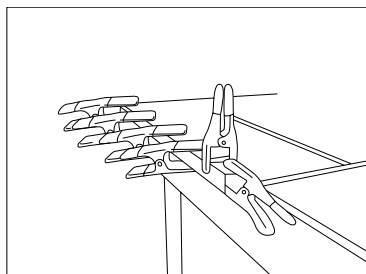

[10-1 - C]

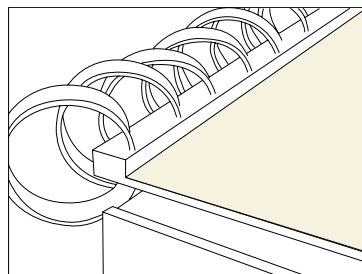

[10-1 - D]

Once all the Edge Buildups are seamed on and dried, route the front edge square to the top.

This can be accomplished by either setting up a straight edge and router with template guide or using a flush cutter

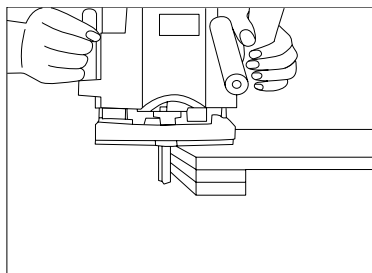

[10-1 - E]

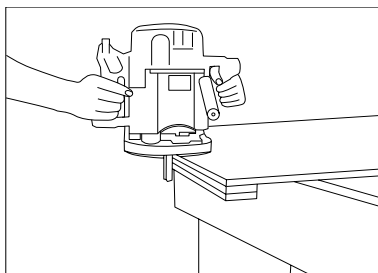

[10-1 - F]

Using Template Guide : To route flush with a straight edge, use router with 25mm(1") template guide and 12mm(½") bit.

Setup the straight edge 6mm(¼") back from the front edge. Clamp in place and route.

Run the router from left to right. This will cut the entire thickness of the buildup flush and keep the front edge square to the top.

Make sure to line up the radius template with the edges already cut.

Repeat the process to cut all the straight sides.

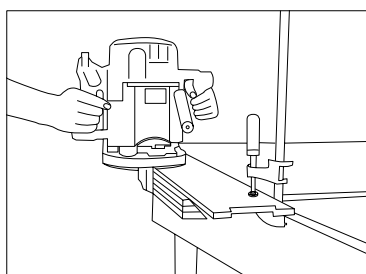

[10-1 - G]

▣ **TIP**

For easy fabrication, use the straight edge system that uses interlocking radius corners and straight lines.

With an interlocking straight edge system, misaligning the straight edge and the radius template could be avoided.

Similarly, with the interlocking system, you can use either the 25mm(1") template guide and 12mm(½") bit and follow the instruction on the previous page or use a flush cutter with the top bearing.

Using Top Bearing Flush Cutter : With a top bearing flush cutter, the straight edge does not have to be set back.

The Straight edge should be placed right on the line to be cut.

Unlike using a template guide, you are cutting right against the Straight edge.

Using the flush cutter will eliminate the chance of any measurement error in trying to set the straight edge back 6mm(¼") to compensate for the template guide.

If the line is traced right off the template, then cut on the line.

Clamp the straight edge down and route the excess material off.

➔ **Note**

Run the router from left to right when using a template.

Once the buildups are cut to size with the router, Decorative Edge can be routed to give the Staron® countertop the elegance and grace...

➔ **Note**

Turn to Decorative Edge Profile for further instructions. (10.5 page 47).

10.2a Drop Edge (Standard)

Drop Edge (Standard) Buildups

➔ **Note**

For the recommended edge buildups to Staron® product that has the larger particulates (Quarry), patterned color (supreme) or pearl particulates (metallic) is recommended for rabbet method, please see 10.2b Drop Edge (Rabbet Method)..

With Drop Edge Buildups, the buildup strips are cut in 25mm(1") width and set on the countertop.

In addition, second piece of Staron® strips are required to be seamed up-against the front piece. This will allow the added strength it requires.

With this method, instead of 2 seams possibly showing in the front edge, there will be only 1 seam and it will minimise the chances of error.

Remember, if the seams are fabricated correctly, you should not worry about seams showing!!!

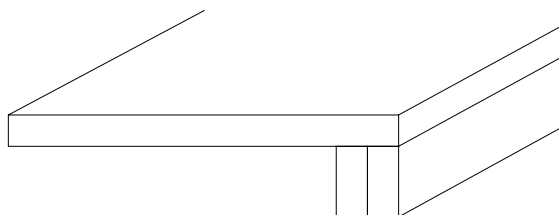

[10-2 - A]

SN-804-2020

When dry fitting all the buildup pieces, place the front pieces (#1) on first.

Temporarily clamp in place for the entire top.

When the front pieces (#1) are all finished, cut and place the back pieces (#2).

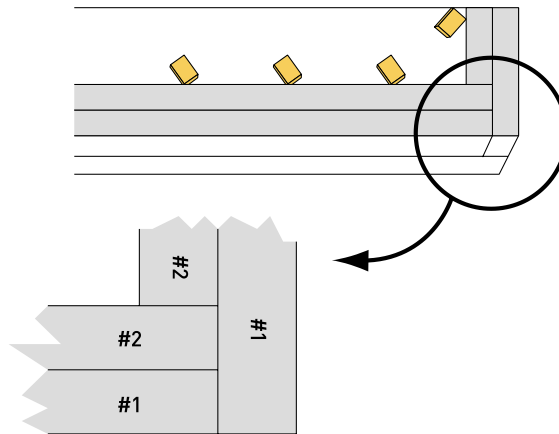

[10-2 - B]

Block the back with wood blocks every 305mm(12") with hot glue. This will help stop the build up from sliding all over the place when the seam adhesives are applied.

Mark the pieces to avoid mix-ups.

Prepare all pieces for seam adhesion by abrading with 150 grit (100 micron) sandpaper, wiping down with denatured alcohol.

Start applying seam adhesive in the corner and work out from there.

Place the seam adhesive where the piece #2 sets.

Seam all the #2 pieces first. When #2 pieces are seamed, apply the seam adhesive on the back area of #1 pieces.

By applying seam adhesive on the back of #1 pieces, this will seam the #1 and #2 pieces together = making them one.

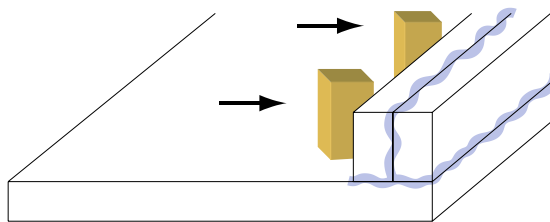

[10-2 - C]

Similar to the Stacked Edges, when the seam adhesives are fully cured, route off excess material and glue from the edge buildup. Refer to section 10.1 for instruction.

TIP

When using Drop Edge buildup method, different colour inlay strip cannot be added during the buildup process.

10.2b Drop Edge (Rabbet Method)

Drop Edge into rabbet is recommended for fabricating Staron® product that has the larger particulates (Quarry), patterned color (supreme) or pearl particulates (metallic) colours. While basic fabrication remains the same as other Staron® colour families, the larger particulates that define the unique patterns in the Quarry require modification to the method which is used to create an edge minimises visible seams at the edge build-up.

On your first Quarry / Metallic project we suggest you experiment, prior to final fabrication, the drop edge with rabbet described next.

Route a rabbet at least 5mm(3/16") deep at the bottom side of front deck edge.

Cut the strips to desired height/width.

The larger and front-facing strip is then adhered to the 4.8mm(3/16") rabbet on the leading edge of the deck (10.2b-A).

Back with a second strip of Staron® to add strength and support.

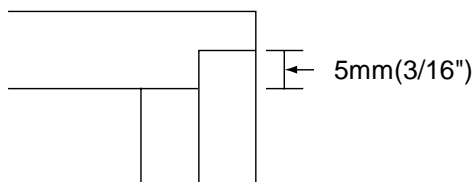

[10.2b - A]

10.3 V-Grooving Buildups

V-Grooving is an easy way to do a drop edge.

We will briefly discuss this type of edge treatment. However, for more details, contact your V-grooving Machine manufacturers.

With V-grooving system, "V" is routed into the Staron® top.

Seam adhesive is placed in the "V" and folded up.

Very few clamps are needed to clamp it closed.

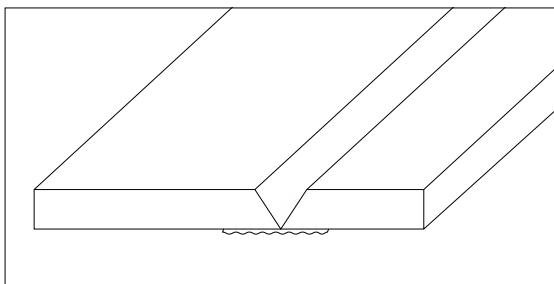

[10.3 - A]

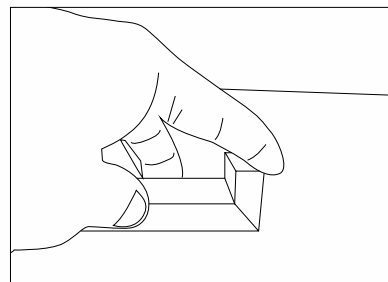

[10.3 - B]

SN-804-2020

Remember that you should prepare the seaming area by wiping out the "V" with denatured alcohol.
When the seam adhesive is fully cured, pull the tape off the front.
There is no additional routing of the edge like in the stacked or dropped edge buildups.
The decorative edge can be routed right away.

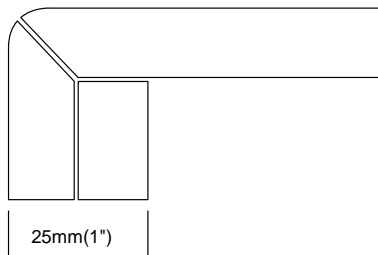

[10.3 - C]

 **TIP**

This method will save fabrication time, however, you will have to purchase very expensive machinery. Similar to drop edge, different colour inlay strip cannot be added during the buildup process. It is strongly recommended that a second piece be seamed behind the front piece for added strength. (10.3-C) All inside corner must have a minimum of 12mm (½") radius, but the bigger the radius the better. Also use a block of Staron® at least 152mm (6") x 152mm (6") in inside corner.

10.4 Inside Corner Buildup

With every Staron® Countertop built with inside corners, it is very important to take precaution in building the inside corner buildups properly to prevent any future cracks from occurring. In order to provide added strength, the inside corner buildups need to be over lapped.

- Stacked Edge Buildups
 - Stack two 102mm(4")x 152mm(6") block pieces in the corner.
- Drop Edge Buildups
 - Stack two 152mm(6")x 152mm(6") block pieces in the corner.
- V-Grooving Buildups
 - Refer to V-Grooving Machine manufacturer for details.

SN-804-2020

Stacked Edge : The two 102mm(4")x 152mm(6") block pieces need to be going in opposite directions. This way, all the seams in the edge buildup will have seam plates built in.

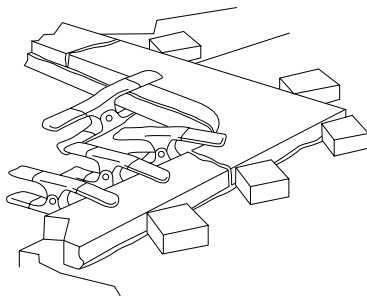

[10.4 - A]

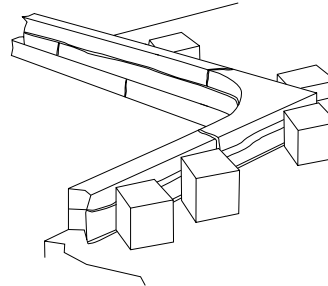

[10.4 - B]

Drop Edge : Use the two 152mm(6") x 152mm(6") block pieces to seam the inside corners together.

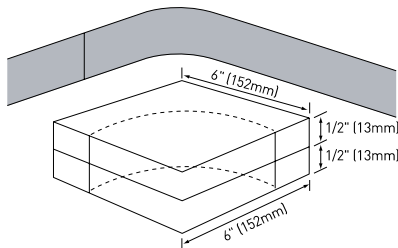

[10.4 - C]

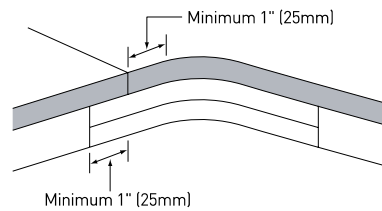

[10.4 - D]

End of 152mm(6") x 152mm(6") corner block must be overlapped a minimum of 25mm(1") or more past from deck seam.

➔ **Note**

Deck seam in buildup edge must be a minimum of 25mm(1") past the radius in the inside corner, but further located seam from the inside corner can better prevent crack(s).

All inside corner must have a minimum of 12mm(½") radius, but the bigger the radius the better.)

When inside corner buildup blocks are ready, seam all the buildups at the same time. 100% glue coverage is required. Remember, with drop edge inside corner buildup, make sure all the pieces line up in the back. There shouldn't be any notch or set backs in the buildups. The notch will act as stress riser.

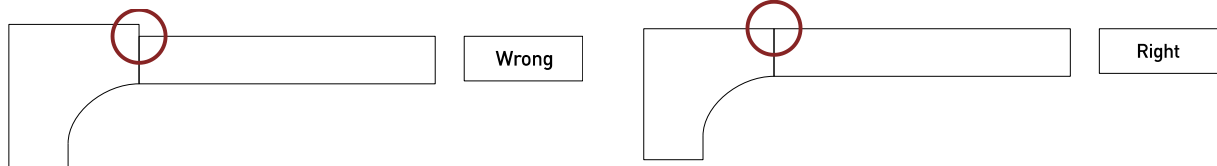

[10.4 - E]

▶ **TIP**

The smoother the edge, the easier it will be to finish the decorative edge profile.

Remember, if the front edge is left rough, the bearing on the decorative edge bit will follow the roughness, which will transfer into the decorative profile. This will take a lot of hand sanding to finish.

10.5 Decorative Edge Profile

Decorative Edges can be added to Staron® Countertop to add beauty and style. Remember, most of the countertops have Decorative Edge Profile. Amongst the following are the most commonly used.

- 6mm($\frac{1}{4}$ "), 12mm($\frac{1}{2}$ "), 19mm($\frac{3}{4}$ ") Radius
- Bull Nose
- Chamfer
- Ogee

Because particulate distribution is heaviest on the top surface, quarter or half round edge routing is recommended for Staron® product that has the larger particulates, such as Quarry series, to minimise the chance of an inconsistent appearance after the edge is completely routed.

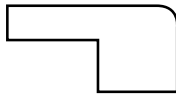

6mm($\frac{1}{4}$ ") Corner Round



12mm($\frac{1}{2}$ ") Corner Round



12mm($\frac{1}{2}$ ") Corner Round
Top and Bottom

TIP

These are often routed both top and bottom of the top. Comprehensive Edge details are listed on the following pages.

Note

There are many different tool manufacturers developing bits for different edge profiling, please consult with the bit manufacturers for details on technical and warranty issues.

Lotte Chemical Corp. Staron® will not be responsible for edge failures due to defective bit, flawed design of the edge, and other related circumstances.

When all the edge buildups are seamed on, cured, routed flush, and square to the top, the decorative edge can be routed on to the top. Mark the place to be profiled and always route from left to right.

When finished routing, the edge needs to be sanded.

Sand the decorative route and the front edge to the desire finish.

TIP

See finishing and polishing section for more details. (18.1 page 87)

Note

Always run the router on a scrap piece of material to check that the router bit is set to the correct depth.

When working with decorative edges that are very extensive, make sure you have enough buildup material and that there are no air holes in the middle of the buildup. They will show when you cut on that spot.

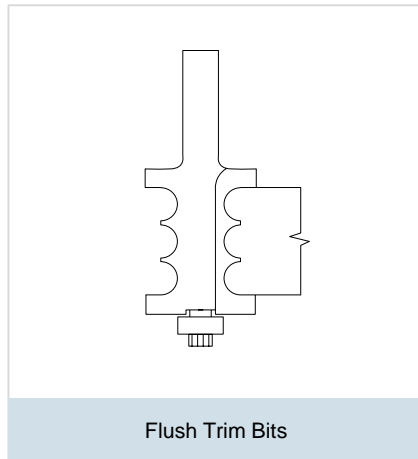

(Olympia)

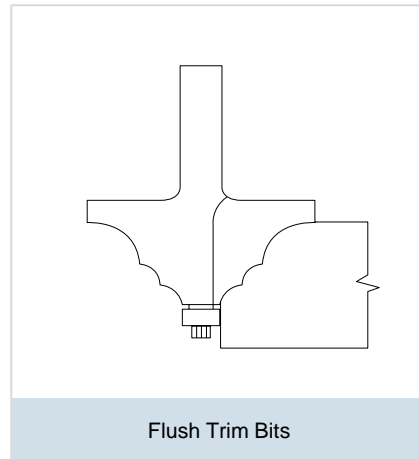

(Hillside)

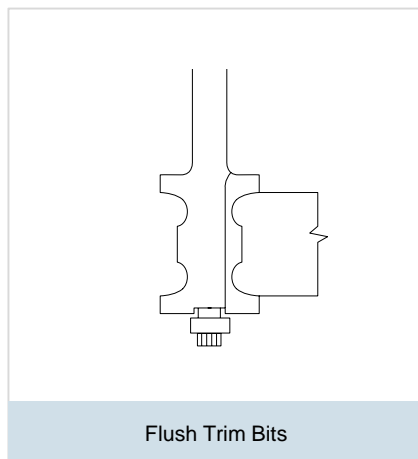

(Oakdale)

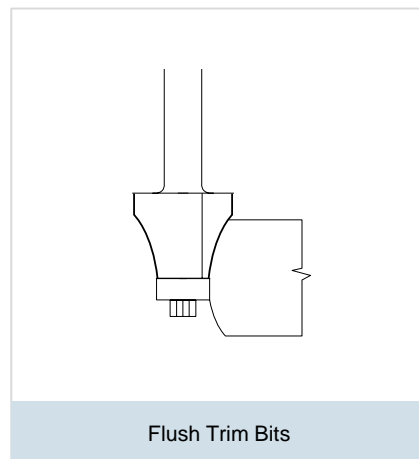

(N.Ocean)

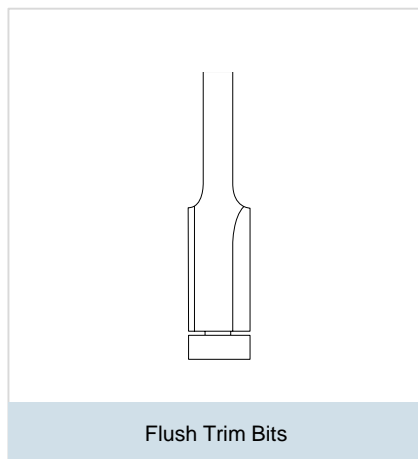

11.1 Overview

Inlays can give added beauty and decorative features to Staron® Countertops.

Inlays could range from decorative stripes in the Edge Buildups, signage, drawing, inscription, and many more for commercial and advanced decorative applications.

There are two categories in fabrication inlays.

- Hard Inlays

Pieces of Staron® are set into a routed slot and seamed together to form stripes and other decorative features.

- Poured Inlays

Liquid resins, ATH (Aluminum Tri-Hydroxide) and pigments are mixed to make the desire colours. These are then poured into routed slots.

11.2 Hard Inlays

Creating a slot in the counter:

Rout a slot with a straight bit.

This slot shouldn't be more than 5mm(3/16") deep.

Less than 5mm(3/16") deep

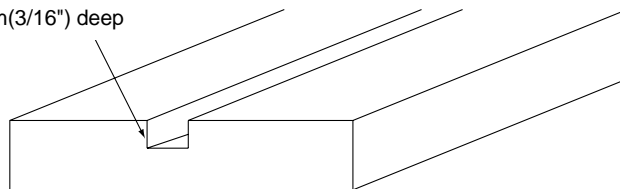

[11.2 - A]

Creating the insert piece:

The inlay insert piece should be cut on a slight angle of 1° to 2°.

Make the inlay insert piece 2mm(1/16") thicker than the depth of the slot.

This will allow the seam adhesive to work it's way out and fill all the edges of the inlay.

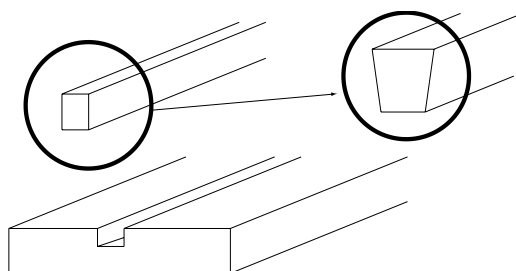

[11.2 - B]

SN-804-2020

Dry fit all the pieces first to be sure everything fits the way it is desired.

Abrade all pieces and slot with 150 grit (100 micron) sandpaper.

Wipe out the slot and the insert pieces with denatured alcohol.

After the alcohol is dried, place the seam adhesive in the corners of the slot.

Place the insert pieces into the slots and rock back and forth to help spread the seam adhesive.

Clamp the insert pieces in place. This will also help spread the seam.



[11.2 - C]

Ski-rout or sand the excess insert material and cured seam adhesive off.

Sand out with 150 grit (100 micron) sandpaper until smooth.

TIP

Remember to always feather out when sanding.

Check for air holes in the seam. Small gaps or air holes can be repaired by mixing some seam adhesive and fill.

Let it cure completely before sanding.

For curved inlays, the insert materials can be thermoformed to fit the desired design. (Refer to Chapter 22 for further Thermoforming instruction)



[11.2 - D]

11.3 Poured Inlays

Poured Inlays are usually used for difficult stripes and other decorative designs which requires more than straight strips. With poured inlays, you are limited only by your imagination.

Poured Inlays(Creating Slot)

On all inlays, do not rout out more than 5mm(3/16") to create the slot. Using your hot glue, create a dam around the slot. This dam will allow for overfilling of "Inlay Kit" to compensate for shrinkage.

TIP

Always overfill the slot with Inlay Kit, This will let the air bubbles rise to the top and compensate for shrinkage of the inlay kit.

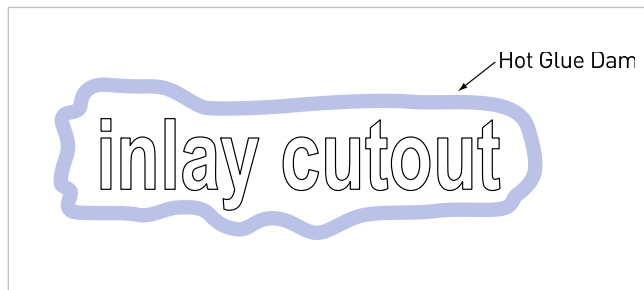

[11.3 - A]

Poured Inlays (Finishing)

Allow the inlay kit to fully cure
 The curing process can take anywhere from 1 hour to 24 hours depending on the amount of catalyst in the inlay kit. The curing times are effected by air temperature and humidity as well.
 (Most Inlay Kits come with instructions)
 When the inlay kit is fully cured, sand the inlay with 80-grit sandpaper to make it even with the countertop.
 Finish the top as before (Refer to Chapter 18)

TIP

If the inlay kit is not fully cured before sanding, the inlay will shrink.
 If too much catalyst is added to speed up the process, it will cause the inlay to crack due to the heat it creates.
 Remember, it is very important to allow enough time for the inlay to fully cure.
 To accomplish intricate designs where more than one colour are needed, repeat the steps to create layers.
 With CNC Machine, you will be able to accomplish multiple layers without sanding.

SN-804-2020

For a setback to a cutout,

- 38mm(1 ½") minimum from the back
- 89mm(3 ½") minimum from the front (undermount)
- 57mm(2 ¼") minimum from the front (drop-in)

12.1 Tools Needed

Recommended Tools

- 3HP Router
- 12mm(½") double fluted carbide router bit
- Templates
- 25mm(1") template guide for router
- Clamps

12.2 Making Cutout Templates

Sink & Bowl cutout Templates are an important part of fabricating Staron® tops.

Sink & Bowl cutout Templates will save you time and materials.

It is recommended to have templates of all the Staron® Sinks and Bowls for faster and accurate cutouts.

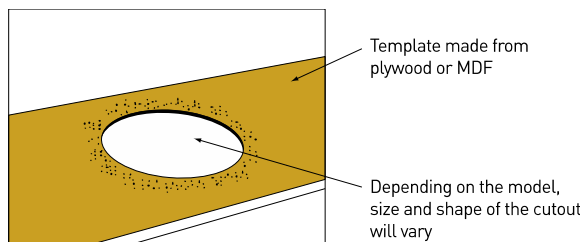

[12.2 - A]

Overview

1. You will need to make a wooden template of the sink to be cutout.
2. Trace the inside of the sink with a pencil.
3. Cutout the pencil mark of the template with a jig saw and sand to the line.
4. When you set the template on the sink, it should be flush to the inside of the sink.
5. If you cannot trace the inside of the sink, trace the outside and add the lip of the sink.

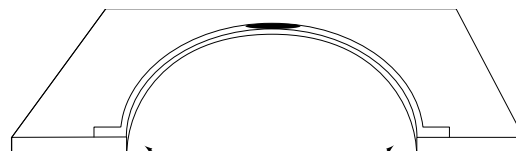

The Template and the inside of the Sink or Bowl should be flush.

[12.2 - B]

TIP

Always mark your template with a centreline and the model number of the shape
Mark what size of bit and template guide to be used.

12.3 Making Cutouts Using Templates

Overview

1. Always use a router for all cutouts.
2. **NEVER USE A JIG SAW ON CUTOUTS !**
3. Use a 12mm($\frac{1}{2}$ ") bit with a 25mm(1") template guide for cutting out your sinkholes.
4. Remember, cutout should be 6mm($\frac{1}{4}$ ") smaller than the sink itself.

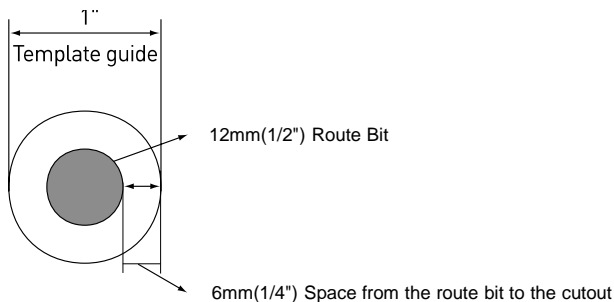

[12.3 - A]

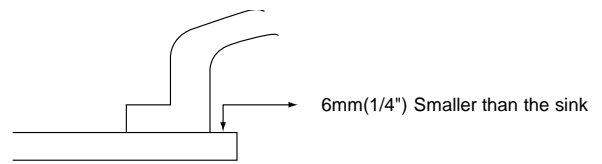

[12.3 - B]

TIP

Another way is to make the template 6mm($\frac{1}{4}$ ") smaller. Use a top bearing flush cutter. Remember, both methods will give same results.

12.4 Making Cutouts Freehand

Overview

1. Sink & Bowl cutouts could be done freehand.
2. Remember, this method is not recommended.
3. Trace the sink on your piece of Staron[®].
4. Add 6mm($\frac{1}{4}$ ") to the inside of the sink.
5. Route freehand along the marking.
6. When routing, always run the router clockwise for smoother cut.

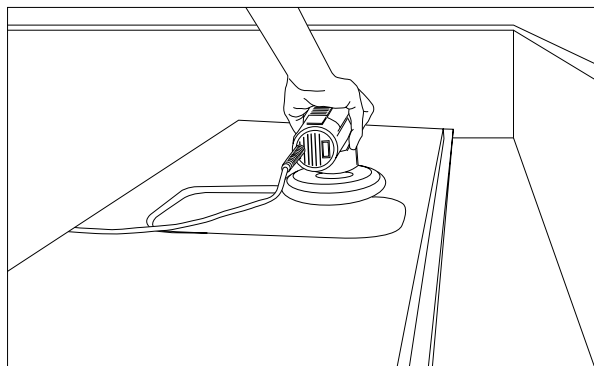

Note

This method is not recommended unless you have years of experience using routers. There is a greater chance of ruining the material and possibility of getting hurt. It is recommended that templates are used whenever possible.

SN-804-2020

13.1 Cooktop Templates

Overview

1. When cutting out Cooktops, always use a router.
2. You can make a template for each cooktop cutout or you can use pieces of MDF (76mm(3") wide) as illustrated in (13.1-A)
3. Remember, unlike sinks & bowls, there are too many different sizes of cooktops for making permanent templates.
4. Draw out the cooktop cutout on the top
5. Remember to centre the cutout front to back.
6. Take your 76mm(3") pieces of MDF and hot glue them to your lines.
7. Put hot glue approximately every 203mm(8") (around 10mm will be enough).

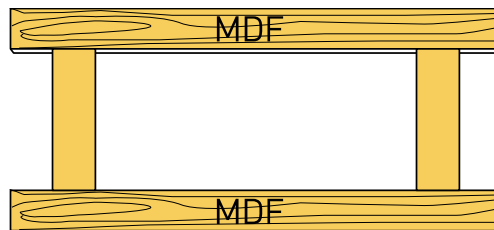

[13.1 - A]

TIP

Make sure all corners are at a 90 degree

13.2 Cooktop Cutout

Overview

1. Take 19mm($\frac{3}{4}$ ") top bearing flush cutter with the bearing 12mm($\frac{1}{2}$ ") way down the MDF.
2. Plunge the bit into and through the material.
3. Run your router clockwise (slowly).
4. When you are finished cutting out the top, spray the wood pieces with denatured alcohol and let it soak.
5. This will help to release the hot glue.
6. Pry the pieces up with a chisel.
7. Use caution, do not chip or scratch the material.
8. Scrape off the rest of the glue with the chisel.

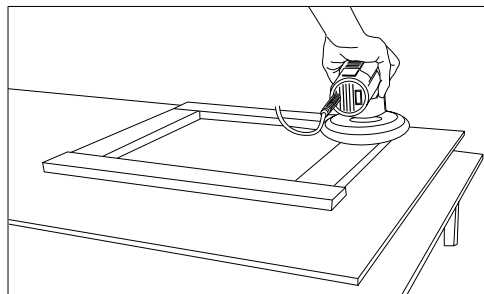

[13.2 - A]

13.3 High Strength Support

Overview

1. Put high strength blocks in the corner of the cooktop cutout.
2. These blocks need to be 102mm(4") by 102mm(4") or larger.
3. They also need to be cut at a 45° angle on all sides except where the piece may touch the buildup.
4. Leave the seam block square, where it touches the buildup.

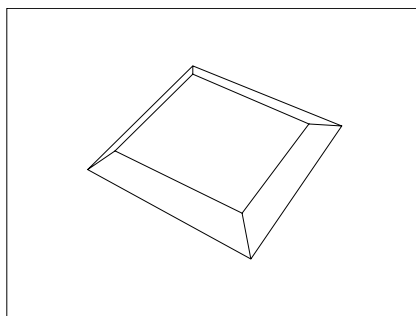

[13.3 - A]

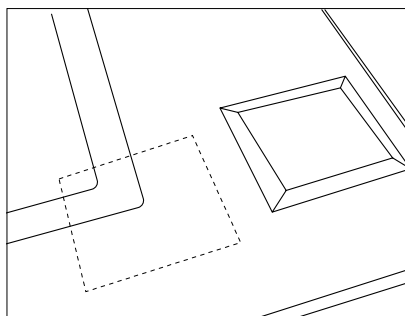

[13.3 - B]

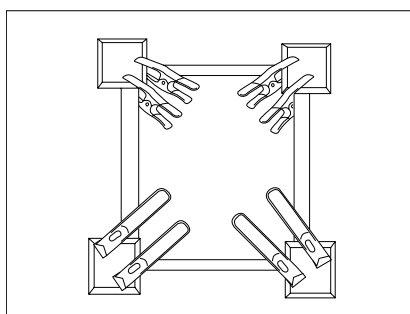

[13.3 - C]

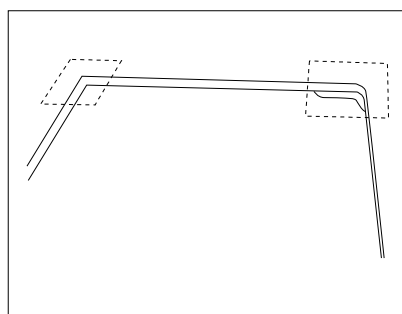

[13.3 - D]

5. When lining up the seam blocks, you need to flip over the top.
6. centre the blocks at the corner.
7. Trace the outside of the block with a pencil or scribe.
8. Seam the pieces to the top using seam adhesive.
9. There must be 100% glue coverage on the Seam blocks.
10. When the seam kit is dry, you will need to cut off the extra material with a router.

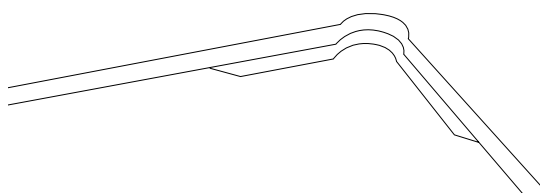

[13.3 - E]

Final Route (Corners of cooktop cutout)

13.4 Final Route

Overview

1. Next, you need to round off the corners.
2. To do this, you will need to raise the bit so the bearing is not below the base of the router.
3. Move the router into the corner (router off).
4. After lining up the router, turn the router on and run the router into the corner at a 45° angle until the bit touches the corner where the two lines meet (prior pencil mark when tracing the cooktop).
Use Router Bit 19mm($\frac{3}{4}$ ") or bigger.
5. Repeat this step at all 4 corners.

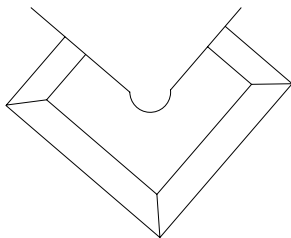

[13.4 - A]

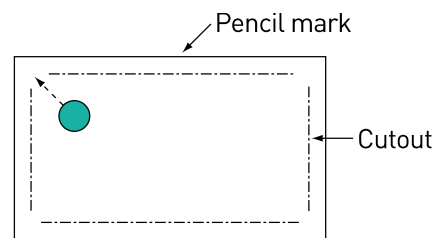

[13.4 - B]

13.5 Sanding

Overview

1. When you get all the corners cut out, you will have to sand the entire cutout with 150 grit (80 or 60 micron) sandpaper.
2. Rout a 3mm($\frac{1}{8}$ ") radius on the top edge of the cutout.
3. Sand this until smooth.
4. Sand the bottom edge with a sander or by hand.
5. You need to get all the chips and router chatter out.
6. Remember, both the top and the bottom have to be sanded smooth to prevent cracks.
7. The smoother you get the cutouts, the better the end result.
8. Finally, you need to put Heat-Conductive Aluminum Tape
(One layer of 4 mils, at least 51mm(2") wide, ex: 3M 425 Aluminum Foil Tapes or similar) around the cutout.
[Please refer to the "Installation" Chapter 19]

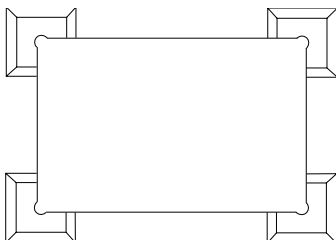

[13.5 - A]

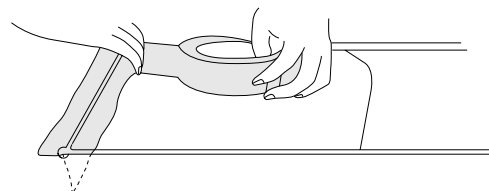

[13.5 - B]

13.6 Potential Problems

Overview

The cooktop area is the area where most failures can occur.
The following is the list of possible causes.

1. Heat - expansion and contraction (excessive heat).
2. Stress points in the cutout.
3. Missing protective heat tape.
4. Faulty cooktop, dispensing too much heat.
5. Not enough space between the cooktop and the countertop.
6. Missing high strength corner or seam blocks.

13.7 Prevention

Overview

Preventive measures.

1. Always use router for the cutouts.
2. Make the cutout as big as possible.
Example: If the cooktop manufacturer suggest the cut out to be 660mm(26")~711mm(28") by 457mm(18")~508mm(20")
; the cutout should be at 711mm(28") x 508mm(20").
3. Minimum of 102mm(4")x102mm(4")x12mm(½") cooktop blocks with 100% glue coverage.
4. 3mm(¼") radius on the top edge of the cutout.
5. "Sand! Sand! Sand!" both top and bottom of the cutout.
6. Use 150 grit (80 or 60 micron) sandpaper on entire cutout.
7. Properly install protective heat tape (Refer to Chapter 19 on Installation)
8. Educate the customer on heat tape and it's proper use.

14.1 Countertop Support

Overview

1. All tops need to be supported every 305mm(12").
2. A normal countertop can be supported with wood strips [24mm(15/16") x 32mm(1¼")].
3. Glue these strips on the Staron® top with 100% clear silicone and hot glue round the perimeter and down the middle.
4. If the Staron® buildup is 51mm(2") wide, you don't need to place wood buildup in the front.
5. It should be on the back and middle only.

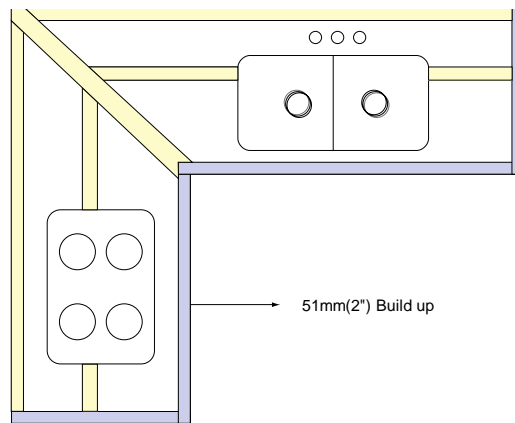

[14.1 - A]

Overview

If the Staron® buildup is 38mm(1 ½") or less, you need to put wood support behind the Staron® buildup as well. Remember to leave 3mm(1/8") gap between the buildup and support.

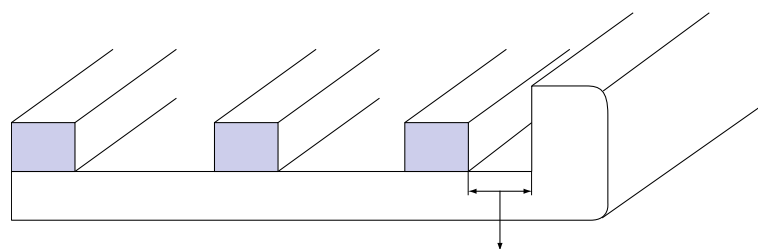

3mm(1/8") Gap between the buildup and support

[14.1 - B]

TIP

100% sub-tops are not allowed.

Remember, you need to have air flow on both sides of the sheet to allow for expansion and contraction.

In some cases, you will need to cut out the cabinet covers.

Framing

Another method of giving support is framing

1. Common technique

Create a perimeter frame in the workshop. Glue the worktop onto the perimeter with silicone. Adjust the worktop to a perfect level when installing.

2. Special technique

Position a perimeter frame on-site and place the worktop over the frame for exact adjustment and leveling with the minimum of adhesion to allow for maximum movement.

The following materials are recommended for a perimeter frame.

- 25mm (1") moisture resistant M.D.F. board.
- 25mm (1") moisture resistant particle board.
- 25mm (1") moisture resistant plywood.

Remember, DO NOT use full underlayment because it can cause heat accumulation and thermal expansion, because Staron® and the wood frames are different materials, heat accumulation and thermal expansion could cause warping or cracking.

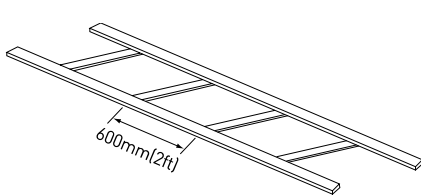

Constructed ladder system

[14.1 - C]

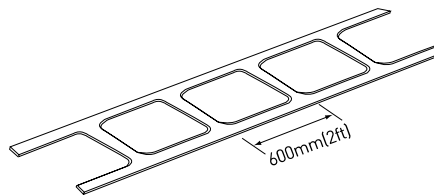

Routed ladder system

[14.1 - D]

14.2 Overhang Support

153mm(6") or Less

Overhangs of 153mm(6") or less do not need to be supported.

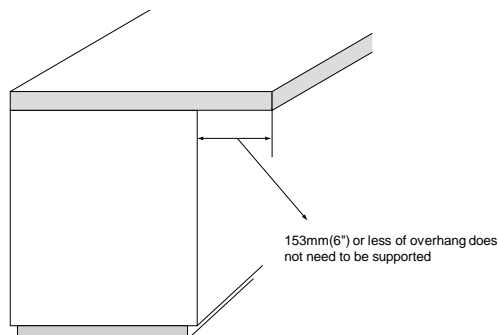

[14.2 - A]

TIP

It is recommended to put a piece of wood under this type of overhang to fill in the void. The customers will appreciate the professionalism.

178mm(7") ~ 381mm(15") Overhang

1. Overhang of 178mm(7") ~ 381mm(15") need to be supported with plywood, metal frame or Corbels.
2. For full plywood under mount, screw the support to the Cabinet from top. (Use 76mm(3") coarse threaded screws)
3. Afterward, silicon the top to the plywood.

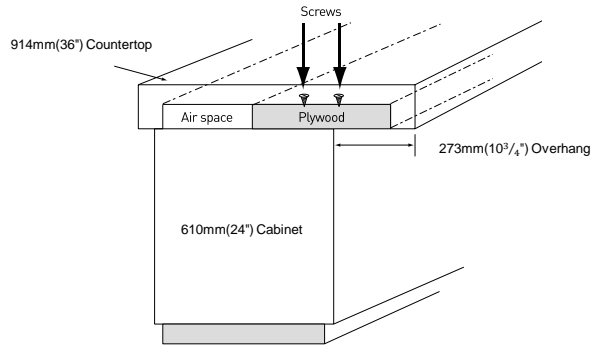

[14.2 - B]

TIP

This is not considered to be 100% sub-top, because there will be 267mm(10 1/2") airspace on the back of the cabinet.

4. With metal frame, you can give it entire coverage, because it is very similar to a "Ladder Support" described in Section (14.1-C and 14.1-D). You will have air on both sides.

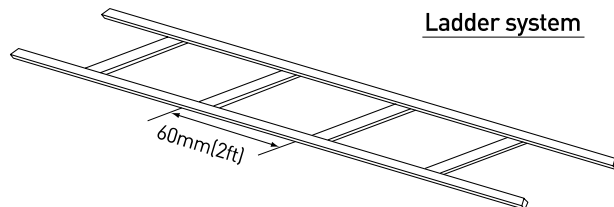

[14.2 - C]

5. Corbels

Usually made out of wood to match the cabinets, they can be made from Staron® materials to match the Staron® top. Corbels need to be 50% longer than the width.

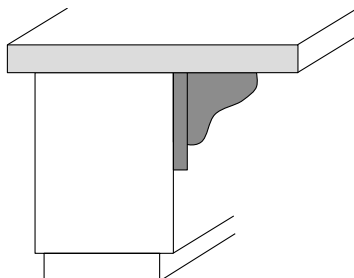

[14.2 - D]

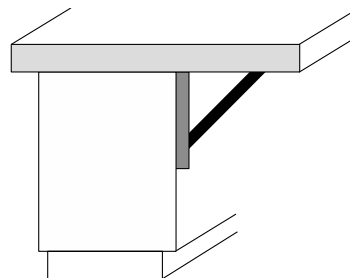

[14.2 - E]

- Brackets must be installed every 600mm (2') or less. Determine the number of brackets to fabricate by measuring the cabinet. Brackets must be long enough to reach within 127mm (5") of the countertop edge.
 - Fabricate the bracket plates that will be used to mount the brackets to the cabinet.
 - Drill screw holes into the bracket plate every 600mm (2') or less determined earlier to match up with the brass inserts in the brackets.
 - Fasten the brackets to the bracket plates using screws.
 - Fasten the bracket plates to the cabinet frame with wood screws before attaching the plywood underlayment.
 - Use one dab of silicone adhesive every 300mm (1') to 457mm (1'6") to secure Staron® worktop to the plywood underlayment.
 - Use one dab of silicone adhesive 25mm(1") from the tip of each bracket.
- Apply dabs of silicone every 300mm (1') to 457mm (1'6") to the upper edges of the cabinets.

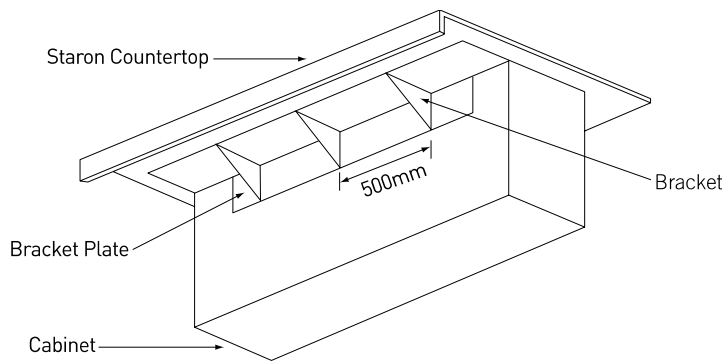

[14.2 - F]

406mm(16") or Larger Overhangs

6. Overhangs of 406mm(16") or more need to be supported to the floor.

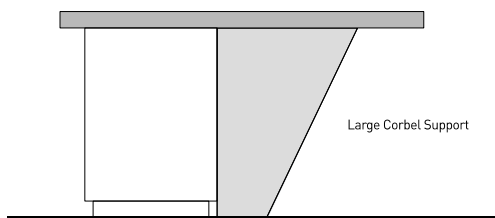

[14.2 - G]

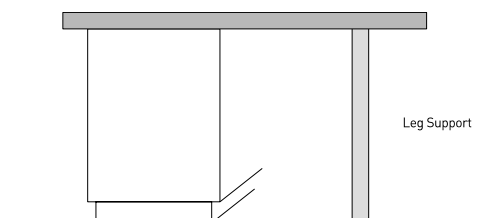

[14.2 - H]

TIP

Both Corbels and Legs could be made of Wood or from Staron®. You will need to support it every 900mm(3').

Overhangs on Raised Bar

7. Overhangs on raised bars for kitchen tops, reception desks and other areas.

You can put full sub-tops on these overhangs.

However, make sure to leave 3mm($\frac{1}{8}$ ") ~ 6mm($\frac{1}{4}$ ") air gap between the wood and Staron® edge.

➔ Note

Because of the air gap and no walls, the materials have enough room to expand and contract.

Screw the plywood sub-top down to the wall using 76mm(3") coarse threaded screws.

When you silicone the top down to the plywood, use 18mm round size dabs every 457mm(18").

Remember, too much silicone will not allow the top to move freely.

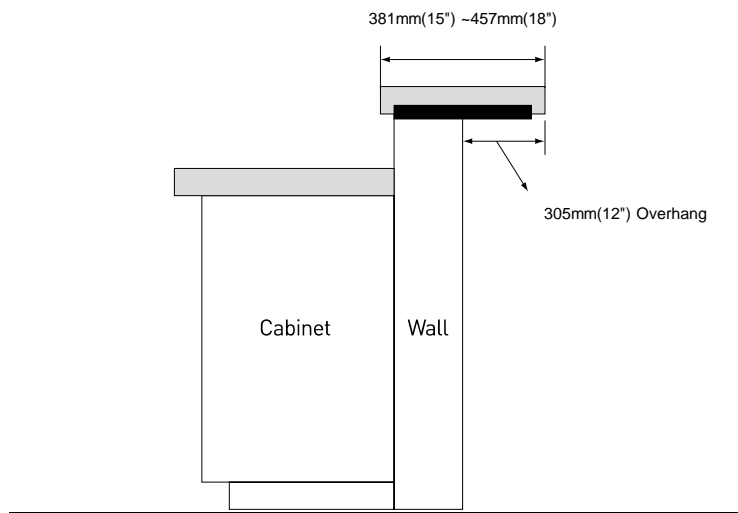

[14.2 - 1]

15.1 Handling Staron® Sink & Bowl

How to mount the Sink & Bowl

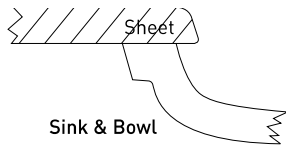

[Under Mount]

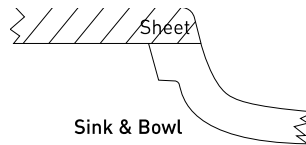

[Seam-Mount]

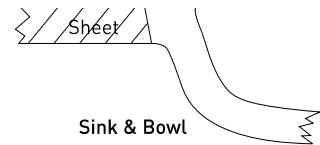

[Angled Mount(Bevel)]

Seam-mount (and Under-Mount)

Seam-Mount or Under-Mount is the mounting method that the face rim of the bowl is glued to the underside of the countertop..

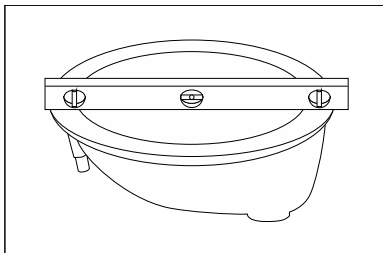

1. Check the bowl rim face for flatness using aluminum level.

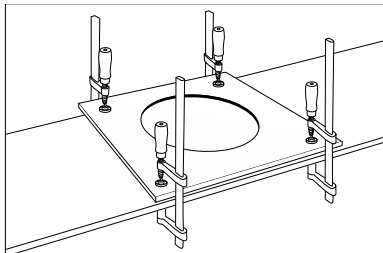

2. Check sheet back for flatness

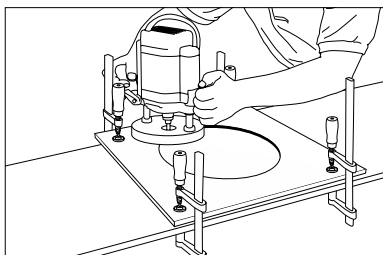

3. Clamp the template into position.

➔ **Note**

Any cutouts not using a router will be void from warranty.

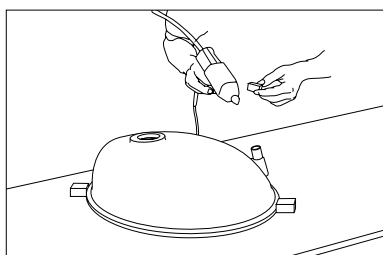

4. Remove the template, position the bowl and fix the bowl positioning blocks into position with hot melt.

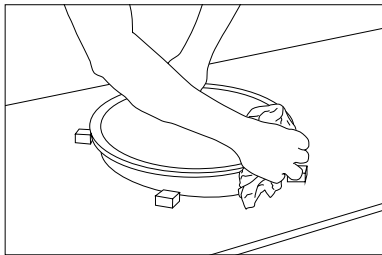

6. Sand the rim for proper glue adhesion.
Clean the rim face of the bowl with denatured alcohol.

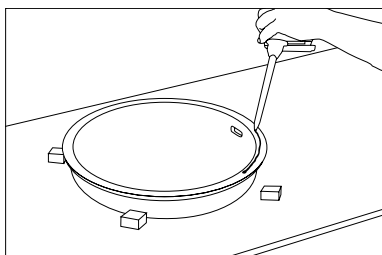

7. Apply Joint adhesive to the rim and glue into position.

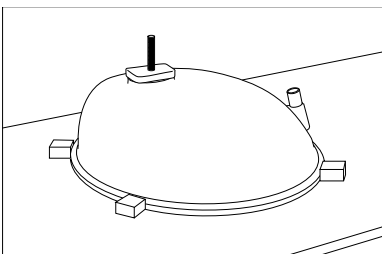

8. Fix them by using clamp and allow to dry.

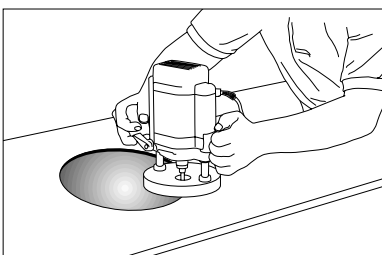

9. Turn the countertop over and route the surplus material to the edge of the bowl with the decorative bit to get the desired edge.

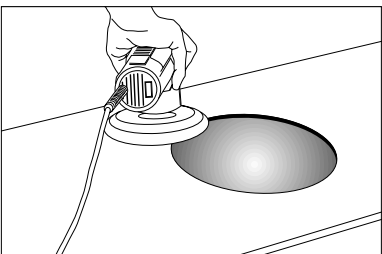

10. Polish the entire surface and bowl to the desired gloss level.

Overflow attachments for Bowls

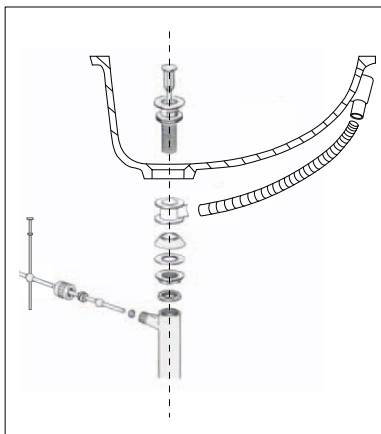

To install overflow attachments, connect all the components as illustrated. It is important to hand-tighten all joints after assembly and installation to prevent leaks.

After overflow attachments are complete, it is now ready to be connected by a plumber.

Angled mount

All the Staron® bowls have a 15 degree bevelled edge, which enables the bowls to be dropped into the sheet so that it fits flush with the sheet surface.

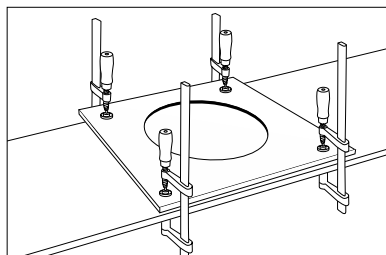

1. Clamp the appropriate template into position on the top of the sheet or countertop.

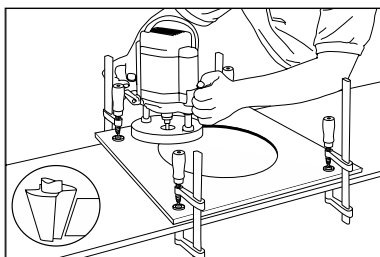

2. Route the bowl cutout with a 30mm sleeve guide and use the router in one motion

3. Route the cutout to a 15 degree bevel finish with an oblique router bit. The first pass should be set 12mm (1/2") below the top surface of the sheet.

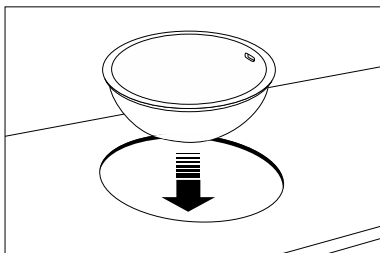

4. Drop the bowl into position for trial fit. The rim face of the bowl must protrude above the sheet to a maximum 0.2mm. If necessary, repeat step 3 several times.

5. Remove template.

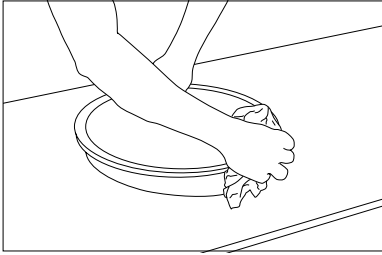

6. Clean the cutout edge and the edge of the bowl with denatured alcohol.

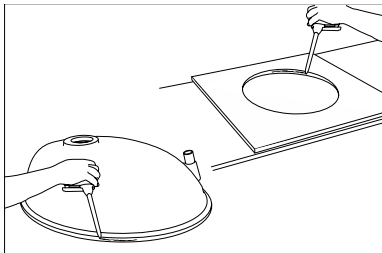

7. Apply Joint adhesive to the cutout edge and to the bowl, then glue them into position.

8. Fix them by using clamp and allow to dry.

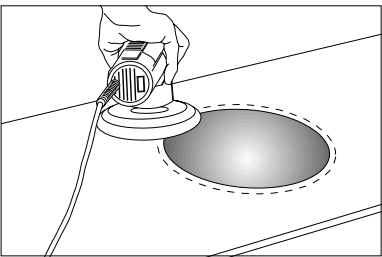

9. Level the sheet with sander.

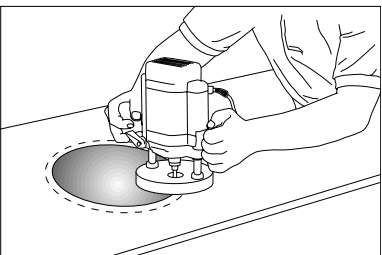

10. Make the edge of the bowl with the decorative bit to get the desired edge.

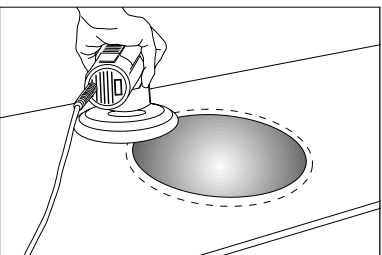

11. Polish the entire surface and the bowl to the desired gloss level.

SN-804-2020

Introduction

- Stainless Steel Bowls
- Cast Iron Bowls
- China Bowls
- Wood Insert
- Wood Edge Insert
- Laminate Inserts
- Handicap Handles and Bars-Shower / Tub Surrounds
- Shower Doors
- Soap Dishes / Shower Caddies
- Tile (ceramic)-Hot Pot Areas

16.1 Stainless Steel Sinks**Stainless Steel Sinks**

Stainless Steel Sinks can be top mounted or under-mounted to Staron® Countertops.

Top Mounted / Drop-In

To top mount or drop in a Stainless Steel Sink, a hole needs to be cut in the countertop.

1. Layout the sink cutout on the counter. Mark the centreline on the top and draw a line with a square from front to back. The measurement back from the front edge should be the overhang + 19mm($\frac{3}{4}$ ") for the cabinet face + 12mm($\frac{1}{2}$ ") for space to accept the sink clips. This will be the front of the cutout.
2. Set up a plunge router (3 HP minimum) with a 12mm($\frac{1}{2}$ ") x 51mm(2") (cut) 2 flute carbide router bit.
3. Plunge the bit into the material so the bit goes through the material. Freehand-run the router counter clockwise on the inside of the line traced out for the cutout. Wood template-Use a 1" template guide + 12mm($\frac{1}{2}$ ") bit and run the router clockwise. Cutout the entire hole.
4. Once the hole is cutout, check to see if the sink fits. If it fits, the cutout is finished. If the sink does not fit, mark and trim as needed.

Under-mount

There are 3 different ways a stainless steel under-mount sink can look.

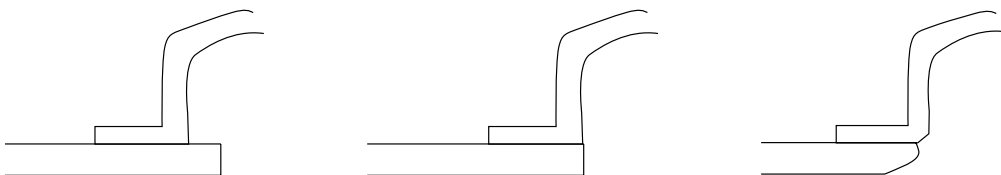

[16.1 - A]

1. Decide which method will be used.
2. Make a template to match the method that was chosen.
3. Cut out the sink hole.

SN-804-2020

4. Sand the cutout smooth with 150 grit (80 or 60 micron) sandpaper and a sander.
5. Route the cutout with 6mm(¼") radius bit.
6. Sand and finish the cutout to desired finish. See Finish and Polishing section. (18.1 page 87)
7. Flip the top over and centre the undermount sink in place.
8. Hot glue the locating blocks. This will allow the sink to be put back in the same place after the silicone is applied.

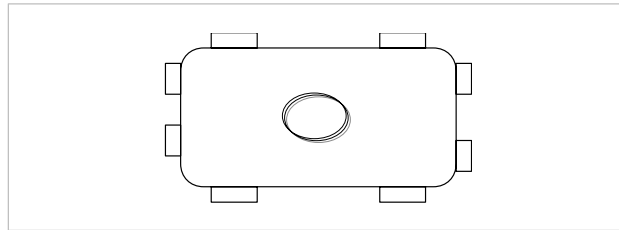

[16.1 - B]

9. Using sink clips from Air Draulics / Chemical Concepts, apply seam adhesive to the underside of the countertop where the clips will be placed.

TIP

Should use 3 clips for the front, 3 clips of the back, and 2 clips on each sides. These should be equally spaced. Make sure the entire base of each clip is covered with seam adhesive. Let it Dry.

10. Lift the sink off. Using denatured alcohol, wipe the rim of the sink and the area where the sink will sit. Let it dry.
11. Apply 100% colour matching silicone to the area where the sink will sit.
This bead should be about 6mm(¼") wide and in the centre of the area.

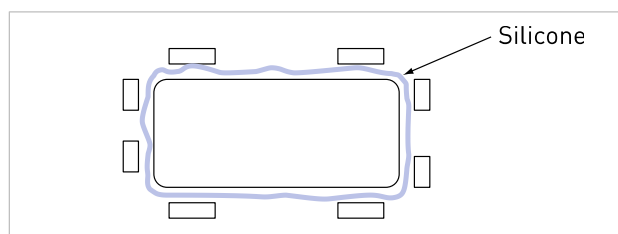

[16.1 - C]

12. Set sink in silicone.
Tighten the clips down all the way.
13. Once all the clips are tightened, get underneath the top and make sure the silicone is coming out all the way around the sink.
DO NOT FLIP THE TOP OVER UNTIL SILICONE IS FULLY CURED!
Spray silicone with denatured alcohol and wipe off the excess silicone.

TIP

If the top is flipped over before the silicone fully cures, the seal can be broken..

16.2 Cast Iron Sinks

Cast Iron Sinks can be either top mounted / drop-in or under-mounted.

Top Mount / Drop

Follow the same directions as the Stainless Steel Sink (Section 16.1).

Under-Mount

Follow the same directions as the Stainless Steel Sink Installation from steps 1-8 (Section 16.1).

9. Make a 1x3 wood frame. This frame needs to be attached to the inside of the sink base. Screw into cabinet and wall, making sure it will hold the weight of the sink, water, and any dishes in the sink.

➔ **Note**

Make sure the wood frame is 12mm($\frac{1}{2}$ ") above the top of the cabinet and centred in the cabinet from side to side.

10. Place the sink on the wood frame.

Attach all plumbing to sink at this time.

11. Bring top in and fit in place. Move the sink around to set it in the centre of the cutout.

12. Lift top off.

13. Apply silicone on the rim of sink using colour-matching 100% silicone.

14. Set top back in place. Push top down all around sink to make sure silicone is coming out. If not, apply silicone bead where needed.

15. Spray silicone with denatured alcohol and wipe excess silicone off.

Do not move top or sink for 24 hours.

16.3 China Bowls

China bowls can be under-mounted following the same directions as Stainless Steel Under-mounts.

➔ **Note**

6mm($\frac{1}{4}$ ") overhang into the bowl is recommended.

16.4 Wood Insert

Wood inserts need to be fabricated using the following directions.

Do not use solid wood only as an insert.

Solid wood can be used, as long as it is backed up with a piece of Staron®.



[16.4 - A]

Flip the top over and lay out the wood first. The wood should be no bigger than $\frac{1}{2}$ the depth of the buildup. After the wood has been laid out, back it up with a piece of Staron®.

Seam only 1 layer on, at a time. After the seam adhesive is cured, the two pieces need to be sanded smooth. Next, the second layer can be applied.

Wipe everything down with denatured alcohol.

Hot glue the wood blocks to fix the pieces after the seam adhesive is applied.

Apply seam adhesive to the back pieces first.

Set the back pieces.

Apply seam adhesive to the backside of the wood between the wood and the back piece. Also apply the seam adhesive to the front edge of the top.

Clamp everything together.

When fully cured, sand the topside of the buildup smooth with 80-grit sandpaper using a sander. Make sure to keep the sander flat. Do not sand the front edge any more!

➔ Note

Remember that wood is softer than Staron® and will sand down faster.

When finished sanding, layout the bottom layer of buildup.

Wipe down with denatured alcohol.

Apply seam adhesive to the back and the front edge of the Staron® piece and to the wood piece.

Clamp the buildup on and let cure.

Once it is fully cured, route and sand the front edge as needed.
Finish to desired finish.
See Finishing and Polishing section. (Chapter 18)

➔ **Note**

Tape off the Staron® and stain the wood after everything is finished.

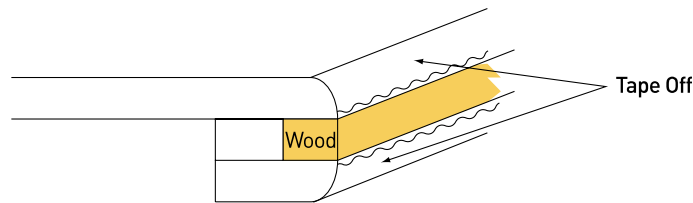

[16.4 - B]

16.5 Wood Edge

Wood Edge

To apply a wood edge to a piece of Staron®, the wood needs to be adhered with 100% pure silicone.

➔ **Note**

Because of dissimilar materials (wood and Staron®), the two will expand and contract at different rates. The silicone will allow this to happen.

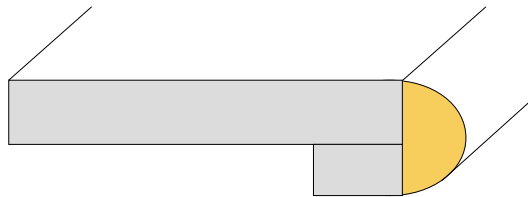

[16.5 - A]

Laminate Insert

Build the top the same as any other top with 2 layers.

After the top is finished, take a rabbet bit [3mm(1/8") x 12mm(1/2")] and rabbet out where the laminate will go.

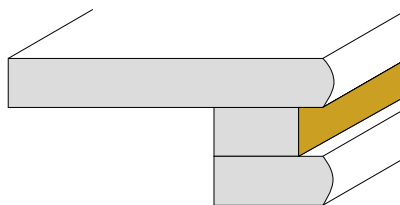

[16.5 - B]

Tape off the Staron® and apply contact adhesive to the rabbet and the back of the laminate.
Let it dry to touch and apply laminate to the top.
Push in place with a rag, making sure to put pressure all the way around the laminate.
Pull tape off and clean up.

SN-804-2020

16.6 Handicap Bars & Handles / Shower Doors

Handicap Bars & Handles / Shower Doors

Remember, all these need to be screwed into wood studs or blocking.
Locate studs / blocking where bars / handles or shower doors will go.
Drill a hole bigger than the screw being used.

TIP

Fill the hole with silicone. Then push the screw through.
This will act like a bushing.

Screw into the wood. It will void from warranty if screwed directly into Staron® products.

Note

Make sure when the Staron® is placed on the wall, there are no voids in the areas where you are placing the handles, bars or doors. If there are voids, the sheets can crack if the screws are tightened too much.

16.7 Soap Dishes / Shower Caddies

Soap Dishes / Shower Caddies (Made from Staron®)

Silicone and hot glue these to the sheets on the wall.
Nothing else is needed.
It is possible to use Seam Adhesive to adhere to the wall.

16.8 Tiles / Hot Pot Areas

Tiles / Ceramic / Hot Pot Areas

When inseting tile into a top, route out the area where the tile will go.
Route this area no deeper than 4.8mm(3/16").

Note

If the tile is thicker than 6.3mm(¼") and the area needs to be routed deeper than 4.8mm(3/16"), then a piece needs to be seamed under that area on the bottom side. This piece needs to be at least 2" bigger than the tile area, all the way around.
Set the tile in silicone. Grout with silicone.

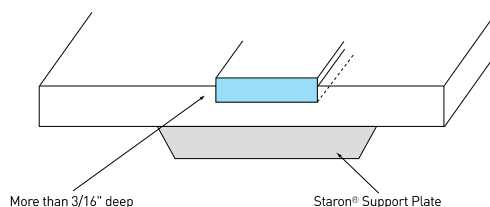

[16.8 - A]

Introduction

There are many different decorative options when selecting Backsplashes for Staron® countertops. Depending on customers' decorative need, they have the option to choose the Backsplash design, material, and decorative finishes.

When working with Staron® Solid Surface, there are three Backsplash options to choose from.

- Loose Splash (Set On Splash)
- Coved Splash
- Full Height Splash

17.1 Loose Backsplash

Loose Splash

Most common and widely used method, this Backsplash is set on the top of the countertop using mainly silicone. Loose Splash can be any height. Generally, they are 76mm(3")~ 102mm(4") high and made of 12mm($\frac{1}{2}$ ") thick Staron® Material.

For the purpose of decorative feature, Loose Splashes usually have 3mm($\frac{1}{8}$ ") radius routed on the top edge.

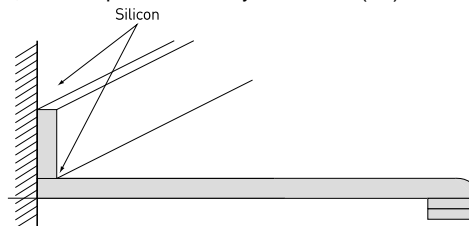

[17.1 - A]

Cut the backsplash strip to the desired width and length.

For $\frac{1}{8}$ " routed top-edge, lay the splash back side down. Clamp to the table.

Mark out where the splash is to get routed. Set up the 3mm($\frac{1}{8}$ ") router bit in a router and route the splash.

(Make sure to run the router from left to right)

When finished routing, sand the splash. (Refer to Finishing and Polishing. (Chapter 18)

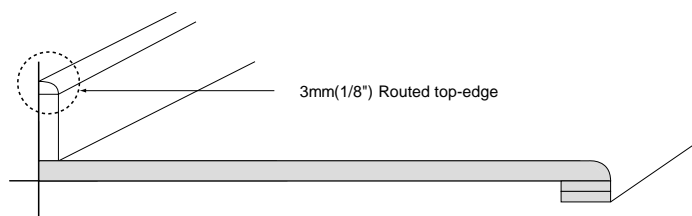

[17.1 - B]

To install a loose splash, run a bead of silicone on the deck (top).

Also, put 18mm round size dabs on the back of the splash. Use hot glue to help hold the splash in place. Hot glue should be placed between the dabs of silicone on the back. These dabs of silicone should be spaced approximately every 305mm(12").

Set the splash in the bead of silicone on the deck and push tight to wall and deck of the countertop.

Lay bead of silicone in corner between the top and splash.

Make sure the bead of silicone touches the splash and the top.

SN-804-2020

Once the bead of silicone is placed in the corner, spray the bead and material with denatured alcohol.

If the silicone bead does not touch both the splash and the top, the denatured alcohol spray will seep under the splash and the silicone will not stick to either the splash or to the top. There will be a void in the silicone.

After the silicone and material have been sprayed, wipe the excess silicone out of the joint. Make sure to keep the joint area wet with denatured alcohol after every time the silicone is wiped off.

TIP

Use a laminate chip with a small 45° angle sanded on one corner.



[17.1 - C]

After the silicone joint has been sprayed, take the laminate chip and place in the corner. Pull the chip from one side to another and wipe off the excess silicone.



[17.1 - D]

17.2 Coved Backsplash

Although coved backsplashes are more complicated than the Loose Splash, It is preferred by many people due to its continuous look from the countertop to the backsplash.

Coved Splashes are not set on the countertop and caulked, they are seamed together with the countertop to make it one piece. There are many different methods of accomplishing the Coved Splashes.

Following are couple of examples.

- Method A
- Hand Held Cove Router
- Shaper With Power Feed
- "V" Grooving

➔ **Note**

To reduce the chance of visible seams at the backsplash, Coved Backsplashes are not recommended to fabrication with Staron® product that has the larger particulates, such as Quarry series, unless V-grooved.

17.2-1 Method A(I)

Method A

Using this method, there are 3 pieces needed.

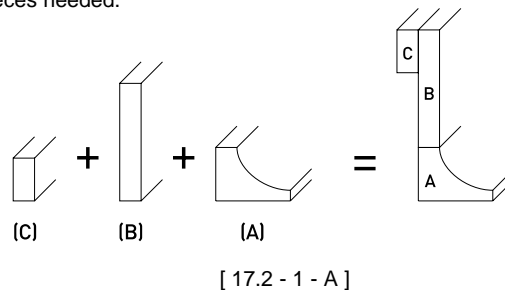

1. Cut a piece of material 127mm(5") wide, the length of the top. Set the piece face up on the table and clamp down. Take 9.5mm(3/8") cove router bit and rout one long edge. Make sure to set the depth of the bit to leave 3mm(1/8") of flat surface on the piece.

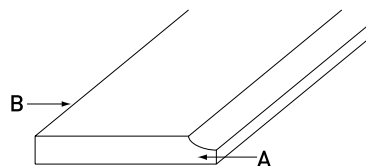

[17.2 - 1 - B]

➔ **Note**

This 3mm(1/8") flat surface will fit into a 3mm(1/8") rabbet routed into the deck of the top.

SN-804-2020

2. After the 9.5mm($\frac{3}{8}$ ") cove is routed into the 127mm(5") wide piece, take a piece of the same material and stand it up on the 127mm(5") piece.

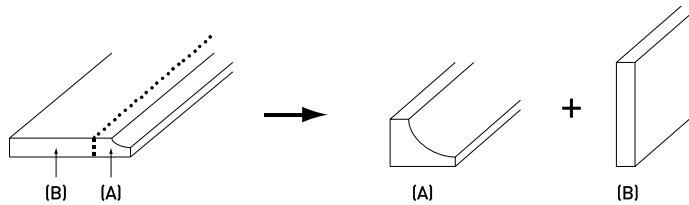

[17.2 - 1 - C]

Set the scrap piece on top of the 127mm(5") piece.

It should be flush with the 9.5mm($\frac{3}{8}$ ") cove rout that was just routed in.

Take a utility knife and put a scratch in the top of the 127mm(5") piece, following the back of the scrap piece. This will give you the exact measurement needed to cut off the cove piece. This piece should be approximately 22mm($\frac{7}{8}$ ") (+/-).

Set the table saw up with a sharp blade and set the fence to the desired width.

(Distance from front edge to scribe line.)

Cut this piece off the 127mm(5") wide piece. This piece will become the cove part of the splash. After cutting this off, the rest of the 127mm(5") piece becomes the splash piece.

3. Place release paper / tape down on the table and set both pieces on the release paper / tape.

The splash should be faced up.

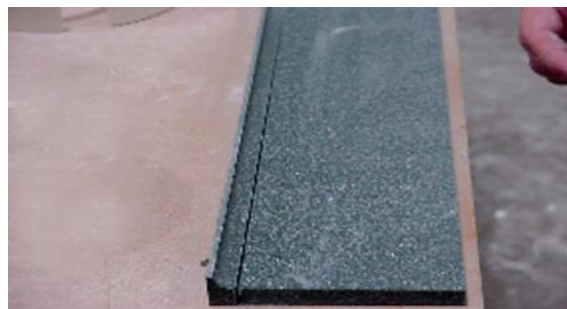

[17.2 - 1 - D]

4. Make sure to abrade the bottom edge of the splash and top of cove piece.

5. Wipe down with denatured alcohol.

6. Place seam adhesive on the cove piece. (6.3mm($\frac{1}{4}$ ") wide bead in the middle of the piece.)

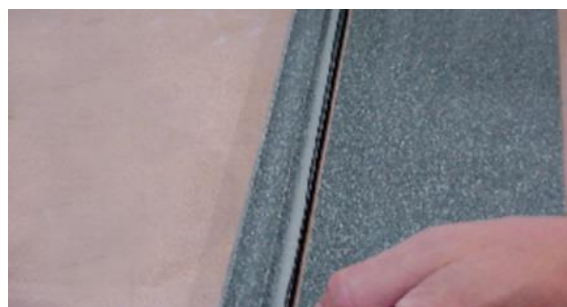

[17.2 - 1 - E]

Flip the cove piece on its backside and clamp to the splash using dani-clamps.
Let it cure.

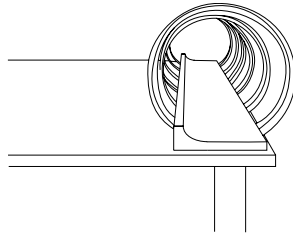

[17.2 - 1 - F]

7. Once the seam adhesive is fully cured, cut down the new covered splash to its final size. Use a table saw and cut down to 105mm(4 1/8") overall.

➔ **Note**

This will make a 102mm(4") high covered splash. The 3mm(1/8") rabbet routed into the deck of the top will take up the extra 3mm(1/8").

8. While the splash is still loose, sand off the excess cured seam adhesive. Use an orbital sander.
9. Finish sanding and route the entire splash to the desired finish.

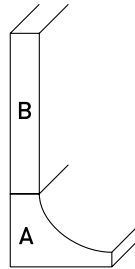

[17.2 - 1 - G]

▣ **TIP**

Use a profile (soft) pad. This will allow the pad to curve to the cove. Be careful not to push too hard into the cove. This could deform the cove.
Start out with 80-grit paper. This will take down the seam adhesive fast.

10. With the deck of the top facing up and the back of the top facing out, take a rabbet bit or wing cutter and route a rabbet 3mm(1/8") deep and 124mm(7/8") wide, along the entire length where the splash will go.

➔ **Note**

The depth of the rabbet should be the same as the lip left on the cove part of the splash.

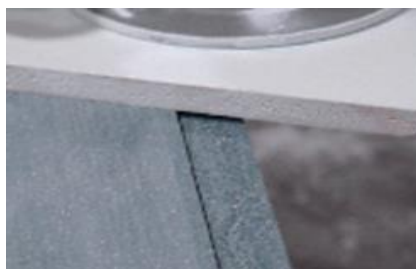

[17.2 - 1 - H]

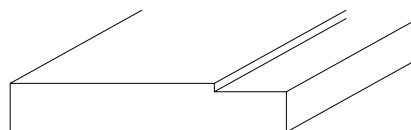

[17.2 - 1 - I]

SN-804-2020

11. Once the rabbet is finished, abrade the rabbet and the bottom of the cove splash.

TIP

With a block sander and 80 grit sandpaper, sand the bottom edge of the cove splash on a slight angle. This will allow the splash to fit easily into the rabbet.



[17.2 - 1 - J]



[17.2 - 1 - K]

12. It is very important to keep the splash square to the deck. One simple way of doing this is to cut some wood blocks (MDF or particleboard) 102mm(4") by 102mm(4") with a 45 degree cut on the bottom.

Cut approximately 2 per foot of splash. These will be hot glued down to the deck.

The reason for the 45° cut is so the wood blocks can be pushed as close to the splash as possible.



[17.2 - 1 - L]



[17.2 - 1 - M]

13. Dry fit the splash and clamp in place. Once this is done, start placing the wood blocks on the top. One should be placed about 51mm(2")~ 76mm(3") in from each end. Then, they should be placed every 305mm(12") from there.

Place hot glue on the bottom of the wood block. Push the block against the splash to make it 90° to the deck.

Push the wood block down to the deck and hold until the hot glue sets up. Repeat this step with every wood block needed.



[17.2 - 1 - N]

SN-804-2020

Once all the wood blocks are set, take all the clamps off. Set the splash upside down, so the bottom is facing up. (Lean against wood blocks.)

14. Wipe down the bottom of the splash and the rabbet with denatured alcohol.
15. When the denatured alcohol is completely dry, apply the seam adhesive to the rabbet area.
Place 3mm($\frac{1}{8}$ ") bead to the front of the rabbet and a 6mm($\frac{1}{4}$ ") bead on the backside, approximately 6mm($\frac{1}{4}$ ") in.

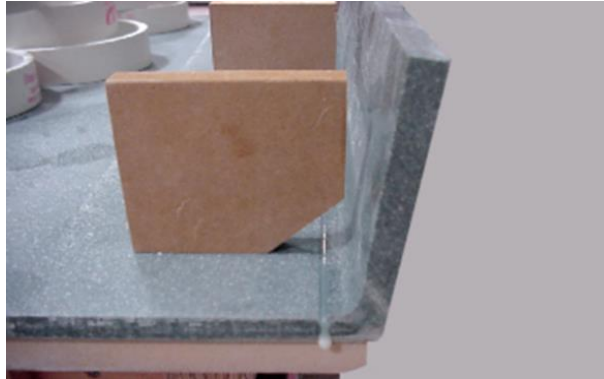

[17.2 - 1 - O]

 **TIP**

When setting the splash into the seam adhesive, set it half way into the 3mm($\frac{1}{8}$ ") bead in front and push forward. This will ensure that the seam adhesive will be under the splash and in the front seam.

16. Clamp the splash downward and from front to back. This will make sure the splash is down all the way and still kept at 90°.

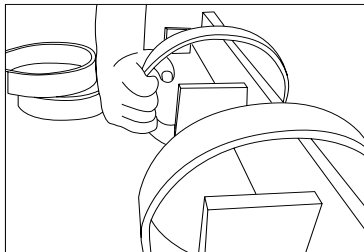

[17.2 - 1 - P]

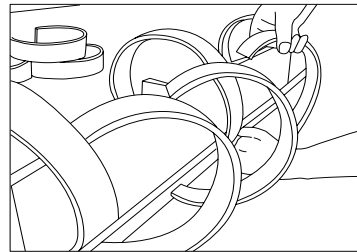

[17.2 - 1 - Q]

17. Let the seam adhesive fully cure. After the seam adhesive is fully cured, take the wood blocks off the top and clean up the hot glue. Sand down the excess seam adhesive with an orbital sander using 80 grit sandpaper. This will take the adhesive down fast.

 **TIP**

The splash piece should already be sanded to finish. Be careful not to sand the cove area too much. Only sand the seam adhesive off and part of the deck.

SN-804-2020

18. Sand this area to the desired finish.
Refer to Finishing and Polishing (Chapter 18)

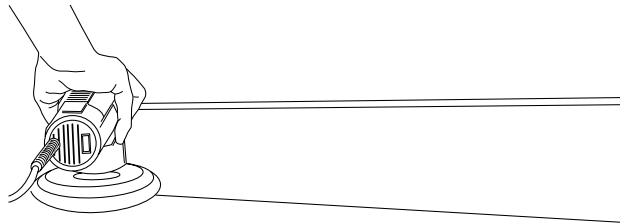

[17.2 - 1 - R]

19. The lower seam of the splash and the deck should be sanded to finish. Now, hand sand the actual cove part of the splash until it reaches the same finish. This will blend the splash and deck areas.
If there is a side splash, follow the same directions mentioned above.
20. mitre both splashes to meet in the corner.
This should be done before seaming the splashes onto the deck.
21. When finished seaming the two splashes together, hot glue two blocks onto the outside of the splashes in the corner.
This will allow the splashes to be pulled together with a clamp. This will ensure a tight seam.

TIP

While the seam adhesive is still wet, wipe the excess adhesive from the corner.
This will make it easier to finish the inside corner.

22. There may be a need to add a scribe strip to the back of the splash.
This will allow the top to be fit to the wall.

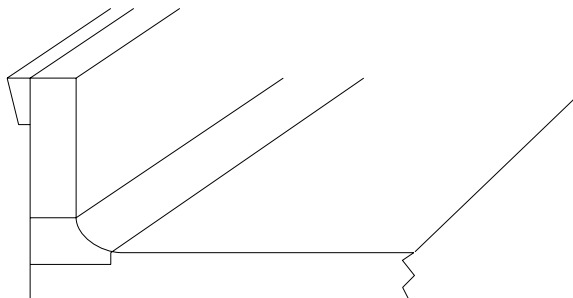

[17.2 - 1 - R]

Decide how much of a scribe is needed. Cut a piece of material to match.

23. Dry fit this piece flush with the top of the splash. Clamp this piece on.

Once it is clamped and fit, hot glue some wood blocks under the scribe piece to the back of the splash.

24. Wipe down both the scribe piece and the back of the splash with denatured alcohol.

25. Apply the seam adhesive to the scribe piece and clamp to the splash.

26. Let the seam adhesive fully cure. Sand the top smooth to the desired finish.

27. Scribe the top to the template. Using a grinder or belt sander, sand down the scribe piece to the line that was just drawn.

TIP

When sanding the scribe piece to the line, tilt the grinder or belt sander on a slight angle towards the splash. Later, this will make it easier to fit the top on the job.

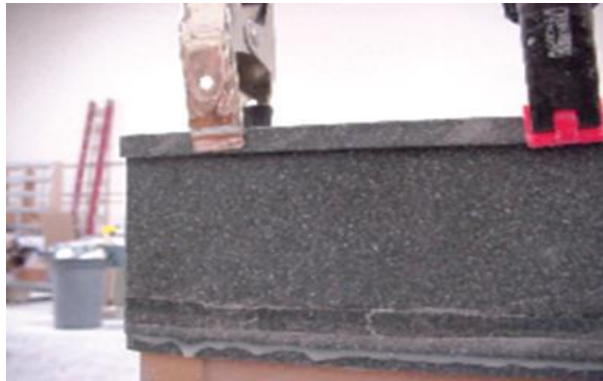

[17.2 - 1 - T]

17.2-2 Method(II)

Hand Held Cove Router

1. Cut a piece of material 9.5mm($\frac{3}{8}$ ") smaller than the height of the splash.
2. The next piece to be cut should be 12mm($\frac{1}{2}$ ") x 22mm($\frac{7}{8}$ ") x length of the top.
3. Abrade the two pieces and wipe down with denatured alcohol.
4. Seam these two pieces with seam adhesive perpendicular to each other.

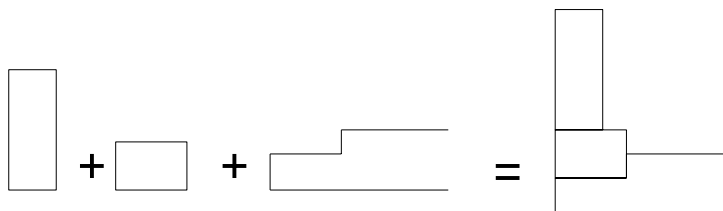

[17.2 - 2 - A]

SN-804-2020

5. Clamp these two pieces together using dani-clamps. Set the clamp every 6" for the entire length.
6. While this is drying, rabbet the deck of the top 3mm($\frac{1}{8}$ ") deep and 22mm($\frac{7}{8}$ ") with rabbet bit.

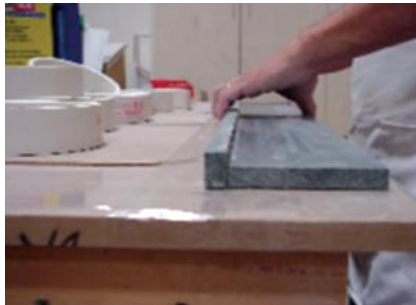

[17.2 - 2 - B]

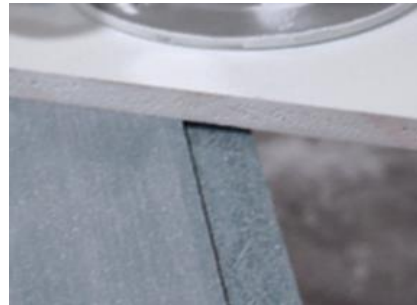

[17.2 - 2 - C]

➔ **Note**

If there is a side splash, make sure to wipe the seam adhesive from the inside corner of one piece. This needs to be clean and clear of seam adhesive to accept a 9.5mm($\frac{3}{8}$ ") x 92mm($3 \frac{5}{8}$ ") x 22mm($\frac{7}{8}$ ") piece of material. This will become the inside corner for the splash.

7. It is very important to keep the splash square to the deck. Refer to the previous cove splash section (Steps 12-16 page 129). Let the seam adhesive cure.
8. Remove the clamp and wood blocks.
9. Set up the cove router so the bit touches the deck and the splash.

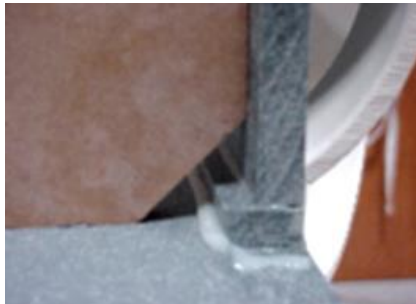

[17.2 - 2 - D]

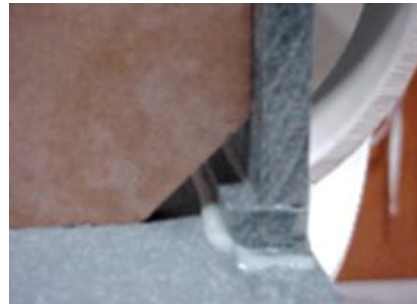

[17.2 - 2 - E]

10. Run the router from left to right; making sure to keep the router tight up against the splash.

➔ **Note**

The router has a 90° wall on both sides of the base. This allows the bit to go all the way into the corner without going too far.

11. Sand the splash and cove area with 150 grit (100 micron) sandpaper to make it smooth. While sanding this area, also sand the deck area near the cove splash.
12. Sand the entire splash, cove, and deck to desired finish.
Refer to Finishing and Polishing Section. (Chapter 18, page 87)

If there are side splashes :

At step #7, set the corner piece in.

Cut the side splash square on the mitre box.

Clamp all three pieces together and seam together.

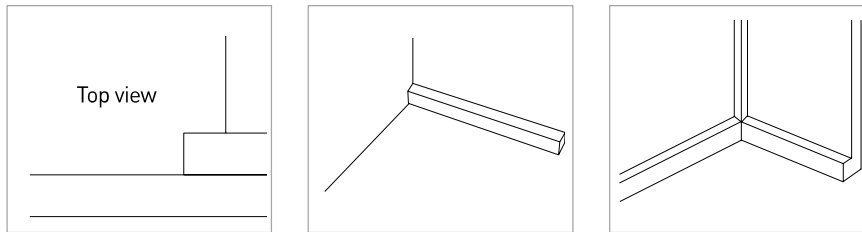

[17.2 - 2 - F]

Remember, the inside corner has to be coved also. To do this, the cove router has to be run up the inside corner. There are two different recommended methods.

- A. Tilt the router on its side and pivot the router up the corner.
- B. Raise the router up the corner.

Be careful not to cut too deep when route plates go above splash.

Once the corner is routed, the only way to sand this area is to sand it by hand.

Sand to desired finish.

17.2-3 Method(III)

Shaper With Power Feed

- This involves a little more investment.
- It is a quick way to make a coved splash.
- There is still a need to seam a "L" shape piece together.
- After seaming this "L" together, run the piece through the shaper.
- With this system, it will save a lot of fabrication time.
- This system routs off all the excess glue from the top seam.
- This leaves very little sanding to do on the splash.
- After this is done, follow steps #11~27 in section #1.

SN-804-2020

17.2-4 Method(IV)

"V" Grooving

This is the quickest way to make a coved splash. But yet, it is the most expensive as far as equipment is concerned. This system involves running the entire sheet through the "V-groover"

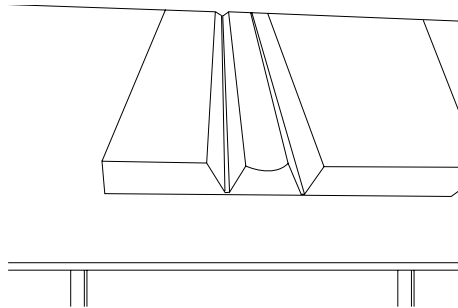

[17.2 - 4 - A]

After running the piece through the machine, wipe out the grooves with denatured alcohol. Then, place seam adhesive in the grooves and fold up.

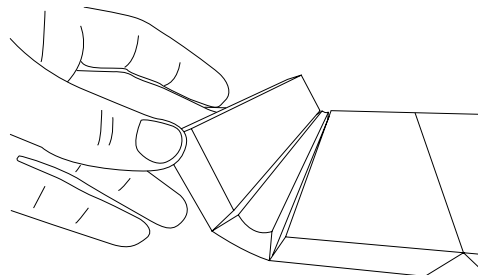

[17.2 - 4 - B]

Using recommended tape, tape the splash in place.
Check with "V-Groove" Manufacturer for further details.

SN-804-2020

17.3 Full Height Backsplash

These splashes run from the top of the counter to the bottom of the upper cabinets.
 After the counter is installed, measure for the full height backsplash.
 If possible, make a template of the wall where the splash will go.
 Alternatively, you can take measurements but mistakes could easily happen.
 Using cardboard is the best way to make a template for the full height backsplash.

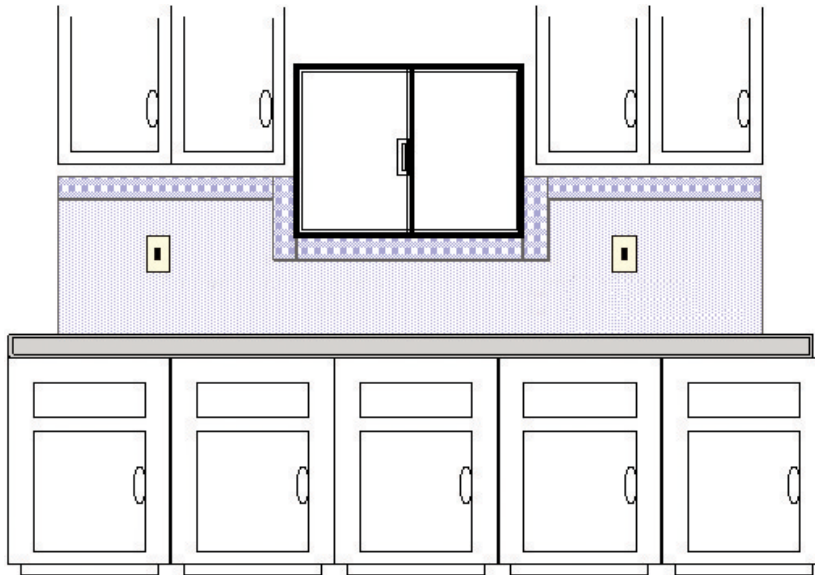

[17.3 - A]

Cut the cardboard to 12mm($\frac{1}{2}$ ") short of overall height and length. If there are different heights, such as under a window or microwave, cut the pieces separately. Make these pieces longer than needed by about 8". This will allow for overlapping and gluing.

Once all the pieces are cut to size, hot glue them together.

After the pieces are glued, cut 1 12mm($\frac{1}{2}$ ") wide strips and hot glue to cardboard, making sure to butt the cardboard strips to the underside of the upper cabinets. This will give an exact template of the splash.

Precut the 6.5mm($\frac{1}{4}$ ") thick material 6.5mm($\frac{1}{4}$ ")~ 12mm($\frac{1}{2}$ ") over size of template. If the splash is longer than what the sheets come in, seam a piece on to make the piece longer than the template.

Once the material is longer than the template, lay the template on the material and trace out (Lay the template flush with the bottom of the material).

After tracing is finished, use a router and straight edge to cut the material to size.

TIP

Cut the outlet or switch holes with a router or a rotozip™.

DO NOT USE A JIGSAW! Make sure to leave enough material so the ears on the switch or outlet can rest on top of the backsplash.

It is the time to finish and sand the entire sheet to desired finish.
Also, rout 3mm($\frac{1}{8}$ ") on any open sides and sand.
(Refer to Finishing and Polishing section. Chapter 18 page 87)

For installation

1. The outlets and switches need to be pulled out.
2. Place pure silicone on the back of the full height splash. Run a continuous bead of silicone all the way around the perimeter of the sheet. Run a continuous bead around all cutouts. Place 18mm round size dabs 305mm(12") apart across the rest of the sheet.

➔ Note

A licensed Electrician should do the electrical work.

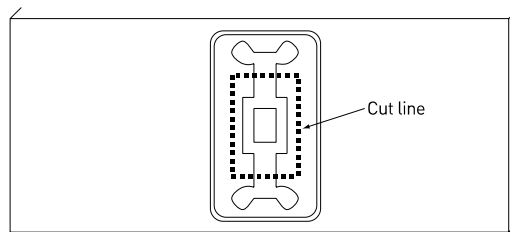

[17.3 - B]

3. Get the piece in place before setting against the wall. Place a few dots of hot glue on the back of the sheet (where there is no silicone). This will hold the sheet in place until the silicone cures. Curing takes approximately 24 hours. Quickly push into place. Make sure to push around the entire backsplash to make sure all the silicone is touching the wall and splash.
4. Replace outlets and switches.
5. Put the covers on the outlets and switches.
6. Caulk the joint between the splash and top with 100% clear silicone.
Lay a bead of silicone in corner between the top and the splash.
Make sure the bead touches the splash and the top.
Spray the bead and material with denatured alcohol.

➔ Note

A licensed Electrician should do the electrical work. The silicone bead needs to touch both the splash and the top. If it does not, the denatured alcohol will seep under the splash and the silicone will not stick to either the splash or the top. There will be a void in the silicone.

After the silicone and material have been sprayed, wipe the excess silicone out of the joint. Each time the silicone is wiped off, make sure to keep the joint wet with denatured alcohol.

■ TIP

Use a laminate chip with a small 45-degree angle sanded on one corner.

After the silicone joint has been sprayed, take the laminate chip and place it in the corner. Pull the chip from one side to the other and wipe off the excess silicone.

7. Finally, caulk (silicone) the joint between the backsplash and the bottom of the upper cabinets. Repeat step #6

18.1 Finishing

Questions to be answered before sanding!

Decide what kind of sandpaper to use:

Standard grit	Average size of grit
Micron Paper / likeness	All grit the same size
Abralon	Can be used wet or dry
Trizact	Must be used damp

We suggest Micron, Abralon, or Trizact for the best result.

Decide what finish the top will have:

Matte	Most common / easiest to maintain
Satin	Most common / easy maintenance
Gloss	High maintenance
Mirror	Extra high maintenance

➔ Note

Any dark coloured solid surface product requires a higher gloss than a Matte finish and also requires additional maintenance and care to retain its original luster. Therefore, dark colours are not recommended in high traffic area as where scratching may frequently occur.

Check to see if the colour of the sheet is light or dark.

Once these decisions have been made, look at the chart in this section for the grits needed to get the desired finish on the colour sheet.

Finish	Standard Grit	Micron-3M	Abralon-Mirka	Trizact-3M
Matte Finish (Light colour)	120, 150, 180, Red scotch brite	80, 60, Red scotch brite		
Matte Finish (Dark colour)	120, 150, 180, 220, 320 Grey scotch brite	80, 60, 30, Grey scotch brite	180, 360, Grey scotch brite	
Semi-Gloss	120, 150, 180, 220, 320, 600-(Wet)	80, 60, 30, 15	180, 360, 500	60 micron Blue, Green Orange, White All Wet
High Gloss	120, 150, 180, 220, 320, (600, 800, 1,000) Wet	80, 60, 30, 15, 9, 5	180, 360, 500, 1,000, 2000, 4000	
Mirror Finish	All of the above plus 1) Marine grade rubbing compound 2) Finesse it compound 3) Liquid Glass as coat.			

[18.1 - A]

▶ TIP

We suggest Micron-3M, Abralon, or Trizact for the best result.
This Chart is only a guideline

SN-804-2020

Method of Sanding

When sanding, make sure to sand in the same direction, every step of the way.
Always sand the top, front to back, side to side and circular motion (clockwise).
The circular motion should be done clockwise in both directions.

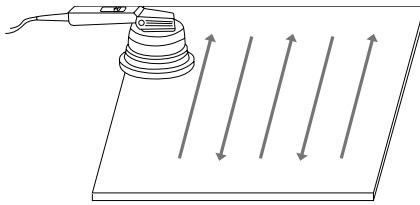

[18.1 - B]

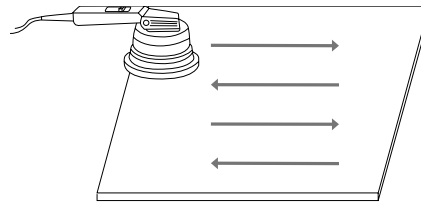

[18.1 - C]

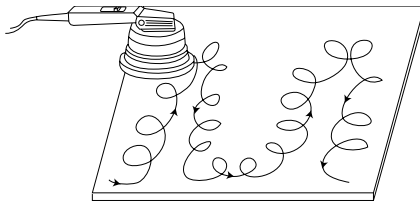

[18.1 - D]

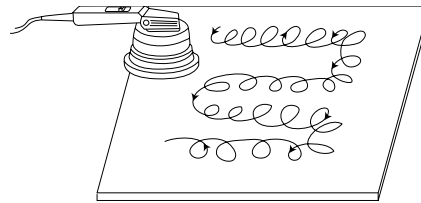

[18.1 - E]

▶ **TIP**

Make sure to wipe dust off after each grit. This dust is the same size as the paper just used. If the next grit is used without wiping it down, then there will be scratches left behind, the size of the previous sandpaper.

Make sure to overlap $\frac{1}{2}$ the distance of the pad on the sander.

Example : 152mm(6") pad = 3" overlap

➔ **Note**

If the circular motion is done counterclockwise, this will leave swirls or pigtails.

18.2 Polishing

Polishing

To high polish a top, there are 3 extra steps that needs to be done after all the steps of Finishing are completed.

1. Marine Paste Rubbing Compound
2. Final Glaze
3. Liquid Glass

Procedure s:

1. Sand the top to a gloss finish.

➔ Note

Make sure that you wipe the top to clean all dusts between each grit of sandpaper. We recommend the use of Dani Designs polishing system. This system has 3 specially designed polishing pads. These pads fit on most random orbital sanders that accept a 5/16" threaded post.

Each of the pads uses special compound.

Pad #1	Used with 3M 's Marine Paste Compound
Pad #2	Used with Finesse-it Compound
Pad #3	Used with Liquid Glass

2. Use pad #1 and 3M®'s Marine Paste Compound. Spread a little paste on the area to be polished. Make sure to set the pad into the compound and coat the pad. Sand the top just as you would with sandpaper on the sander. Use the same method front to back, side to side, and a clockwise circular motion.
3. Wipe down the countertop, making sure to get the entire compound residue off.
4. Change the pad to Pad #2.
5. Follow Step #1, except using Pad #2 and the Finesse-it Compound®.
6. Wipe down the countertop of all compound residue.
7. Follow Step #1, except using Pad #3 and Liquid Glass®.
8. Once the Liquid Glass® has been worked into the top. Wait about 5 minutes, then buff the surface. The polish will dry and get hazy When buffing, use the same pad, moving quickly.

➔ Note

Liquid Glass® can be found in an automotive store. This polish is used on clear coat finishes for cars.

▶ TIP

With this system, if there are minor scratches caused by installation, there is no need to resort to sanding. The minor scratches can be taken out with using just buffing pads and compound. It will blend right in.

19.1 Transportation

The best way to transport the Staron® top is standing up on edge.

Always put blankets between tops. This will keep the tops from banging against each other and prevent a possible damage.

This method can be used in any kind of truck or cube van. Build an "A" frame in the truck or use "A" frame carts with wheel and wheel locks.

Always strap tops to the cart and strap the cart to the truck.

Tops can be transported flat, but make sure all areas are supported well.

The weight of the top can cause stress in the top, especially when hitting bumps on the road.

19.2 Site Preparation

Check to be sure cabinets are flat to within 3mm($\frac{1}{8}$ ").

Shim to flat, if necessary.

If the top is installed on uneven cabinets, over 3mm($\frac{1}{8}$ "), it will void the warranty.

Make sure there is support around all cabinet openings. 1 x 3 wood between cabinets at DW, back wall. 1 x 3 wood on back wall around lazy susan area.

➔ Note

Screw these into 2 x 4 studs with coarse threaded screws and make sure they are level with the cabinets.

■ TIP

Cover all heat and AC vents in floor or near where the top is being installed.

This will save headaches down the road. Dust will settle in these vents until the customer turns on the heat/AC. Then, the dust from the installation will blow throughout the house. The customer might call and complain and possibly send out a bill.

Put up plastic around doorways. This will keep the dust contained to the room you are working in.

19.3 Carrying & Positioning

Always carry the top on edge. **Do not carry the top flat!**

When setting the top in place, set back edge on cabinet first.

Then slide back of the top to the wall and set the front edge down.

➔ Note

Make sure to have at least two people carrying and setting the top in place.

It is important that you work together.

Do not get the top twisted or jammed in place.

This will cause stress in the top and possibly break.

19.4 Dry Fitting

Dry fit the seam after setting the top in place.

➔ Note

- Make sure to leave 3mm($\frac{1}{8}$ ") gap at walls for expansion.
- Expansion gaps should be 3mm($\frac{1}{8}$ ") per 10' of top between walls.
- Shim top as needed. Everything should line up. The top should be flat.
- Scribe the top as needed.
- Scribe with a 102mm(4") angle grinder and 50 grit disc.
- A belt sander can be used carefully. Do not heat up the material.

▶ TIP

- When scribing the top, angle the top back at a slight angle.
- This will help when fitting tight to the wall.



[19.4 - A]

- Abrade seam with 80-grit sandpaper.
- Make sure not to hit the top 1.6mm($\frac{1}{16}$ ") of routed seam.

19.5 Seam Plate

- The top should touch the whole seam plate. If the seam plate is lower than the bottom of the top, then shim up the seam plate.
- Make sure everything stays flat and lined up.
- Set up whatever clamping system is to be used. Clamp up the seam, without seam adhesive.
- After the top is clamped dry, check to see if the seam disappears.
- If it does, then everything should be lined up correctly.
- The top is almost ready for the seam adhesive.
- Check to see if the cook-top fits. If it does not, then cut the cutout bigger.
- It is easier to do this now, rather than after the top is finished.

19.6 Faucet Holes

- Use a standard hole saw (6.3mm($\frac{1}{4}$ ") pilot bit).
- Kitchen faucets should use 34.9mm($1 \frac{3}{8}$ ") hole saw. The centre of the hole should be 57.2mm($2 \frac{1}{4}$ ") back from the inside of the bowl.
- Vanity faucets should use 28.6mm($1 \frac{1}{8}$ ") hole saw. The centre of the hole should be 54mm($2 \frac{1}{8}$ ") back from the inside of the bowl.

➔ Note

- Do not twist the drill in the hole. This will cause stress in the top and it could break the top.
- Be careful not to push too hard on the drill. If you push too hard when the hole is almost all the way through, the drill will slam into the deck of the top. This could cause a crack in the top.
- A 3mm($\frac{1}{8}$ ") radius can be routed around the hole. But, it is not necessary.
- There is very little stress in this area.

19.7 Final Placement

Once everything is in place and ready to go, wipe the seam area and seam plate area with denatured alcohol.

➔ Note

Make sure to wipe the underside of the top around the seam area.

Check to see that there is no ink from the sheet numbers in this area.

If the seam adhesive touches the ink, it could seep into the seam and discolour the seam.

Lift the top off the cabinets and carefully set it down. Place 18mm round size dabs of 100% clear silicone every 305mm(12")~381mm(15"). Set the largest piece in place first.

Do not set the smaller section to be seamed in place now.

Get the seam adhesive ready to go.

Lift the large piece so that seam adhesive can be applied to the top of the seam plate.

Once the seam adhesive is in place, set the large top down. Now, silicone where the smaller piece goes.

Set the smaller piece in place. Leave about 3mm($\frac{1}{8}$ ") gap between the two pieces.

Seam adhesive should already be on the seam plate.

Fill the 3mm($\frac{1}{8}$ ") gap with seam adhesive. Start at the underside, in the front and work up towards the deck.

▶ TIP

Tape off the front of the cabinets. If the seam adhesive drips down, it will not stick to the cabinets.

Have a laminate chip ready to clamp to the underside of the seam area in the front. This will help keep the seam adhesive in the seam and not on the floor or the cabinet. Make sure to clamp the shiny side up towards the seam adhesive.

This way, the seam adhesive will not stick to the laminate chip.

Once the front edge is filled, clamp the laminate chip in place on the underside.

Fill the gap from back to front. Pull the seam adhesive instead of pushing the seam adhesive.

Pull the seam together with whatever clamping method is decided.

Let it fully cure!

After the seam adhesive is fully cured, sand the seam with 80-grit to start.

Finish to the desired finish. Blend it into the rest of the top.

➔ Note

Everything should have been sanded except 152mm(6") on either side of the seam.

All of these should be done in the shop. The seam area is the only area left to finish at the installation site.

Make sure to feather out the seam area with each grit of sandpaper.

Do not stay in one area. If you do not keep moving, it will create a valley effect.

Clean up inside and outside.

▶ TIP

Leave the site cleaner than you found it. This will go a long way with the customer.

Install the backsplash at this time.

19.8 Anchoring Dishwasher

There are two ways to anchor a dishwasher.

- 1) 6mm($\frac{1}{4}$ ") Brass anchors (push in type)
 - Drill (6mm($\frac{1}{4}$ ") hole 12mm($\frac{1}{2}$ ") deep. Push the anchor in.
 - Screw through dishwasher bracket into anchor.
- 2) Piece of wood behind solid surface buildup-siliconed in place.
 - Screw 19mm($\frac{3}{4}$ ") wood screws through dishwasher bracket into wood.
 - DO NOT SCREW DIRECTLY INTO Staron®**

19.9 Preparing Cooktop Cutout

- 1) Place Heat-Conductive Aluminum Tape (One layer of 4 mils, at least 51mm(2") wide, ex: 3M 425 Aluminum Foil Tapes or similar) around the cutout.

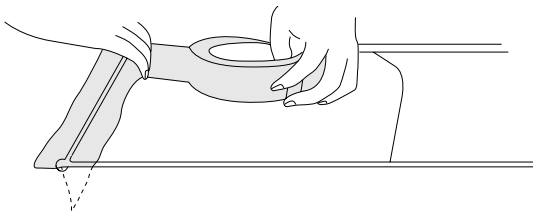

[19.9 - A]

Put two continuous layers of heat tape around the cutout.
Overhang the top by 6mm($\frac{1}{4}$ ") and let the rest hang down.

➔ Note

Everything should have been sanded except 152mm(6") on either side of the seam.
All of these should all be done in the shop. The seam area is the only area left to finish at the installation site.
Make sure to feather out the seam area with each grit of sandpaper.
Do not stay in one area. If you do not keep moving, it will create a valley effect.
Clean up inside and outside.

19.10 Do's and Don'ts

Do's

- Clean with soap and water, using a sponge.
- Use a Scotch Brite™ with soap and water on the top to get stains out.
- Clean with ammonia based products (Windex™, 409™, etc.).
- Run cold water in sink when dumping boiling water.
- Use cutting boards, whenever possible, to protect the top.
- Use trivets or hot plates, instead of putting hot pans on the top.
- Fill the sink with water and ¼ cup of bleach. Let set for about one hour. Rinse and scrub with a Scotch Brite™ pad. This will make the sink look new.

Don'ts

- Do not use Comet™ or Ajax (anything abrasive) on the top.
- Do not cut directly on the top.
- Do not use the Scotch Brite™ pad dry. It will act like sandpaper.
- Do not set anything hot on the top. Always use a trivet or hot plate.

TIP

Always leave at least two square feet of colour matching material with the job. This is for future use, in case the top gets damaged.
(Store it in safe place for future use)

Square these off and route with 3mm($\frac{1}{8}$ ") radius on the top and bottom.
Sand and put rubber feet on the bottom.
Customers always love these cutting boards since they were not expecting it.

20.1 Overview

In addition to creating beautiful Countertops, Staron® 100% Acrylic Solid Surface can be used in many different applications. Ranging from furniture, sign, shower wall, stair rail.....

- Shower walls
- Tub Surrounds
- Wainscoting

All of these applications are fabricated and installed in a similar way.

20.2 Fabrication and Installation

Measure or template the walls.

Cut the pieces oversized by around 12mm($\frac{1}{2}$ "), all the way around.

➔ Note

If sheets are seamed together, make sure it is safely handled.

Trace out the template or layout the measurements on the sheet. Cut to size with a router.

Sand to desired finish. See Finish and Polishing section.

Make sure there is at least a 3mm($\frac{1}{8}$ ") gap on each side if the sheet runs between walls. This is for the sheet expansion and contraction.

Do not seam inside corners in shower surrounds or tub surrounds.

Corners must be filled in with 100% silicone. The outside corner can be seamed.

Dry fit the pieces after everything is cut to size and sanded.

Attach to the back walls first and the side walls.

➔ Note

After the back wall is installed, measure for the faucet holes.

To attach the walls, place a bead of 100% silicone all around the perimeter of the sheet. Then, place quarter size dabs of silicone every 305mm(12").

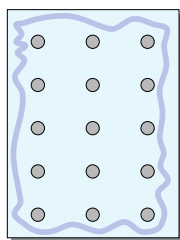

Hot glue between silicone dabs to hold in place, until the silicone cures.

[20.2 - A]

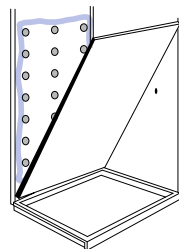

The bead will seal the backside and the dabs will pull the sheet to the wall when fully cured.

After the back wall is in place, dry fit the sidewalls. Scribe as needed against the back wall.

➔ Note

Sidewalls should be tight against the back wall.

If there is a glass door being installed, leave a 3mm($\frac{1}{8}$ ") gap at the door side of the sheet.

SN-804-2020

Cut the faucet holes with a router or Rotozip™ type tool.

Do not try and cut these holes while the sheet is on the wall.

Silicone as needed to attach the sidewalls.

Once all the walls are installed, wipe down with denatured alcohol.

Silicone all joints with colour matching 100% silicone.

Spray with denatured alcohol and wipe the joints clean.

See loose backsplash section.

TIP

Remove excess silicone before it gels with a putty knife and clean it in a couple of minutes.

Start at the bottom and work your way up. This keeps the alcohol from getting into the joints before the silicone is cured.

If the denatured alcohol gets into the joint before the silicone, the silicone will not stick. It will not seal.

If the sheets cannot be seamed for some reason, there are two other ways to line the sheets up or hide the seam area.

1. Batten Strip

Using a piece of material, approximately 51mm(2") wide set over the seam.

This piece is siliconed on top of the two sheets.

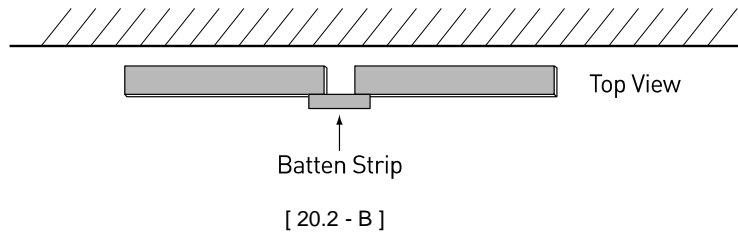

This allows for expansion and contraction.

The batten strip is also the same thickness as the sheets.

Route a 3mm(1/8") radius on both long sides.

2. 45° Beveled

The other way is to route 3mm(1/8") at 45-degree bevel on the two sheets and sand.

Leave a 1.2mm(1/16") gap when attaching to the wall.

Fill the 1.2mm(1/16") gap with silicone.

Spray with denatured alcohol.

Wipe the joint smooth and clean up.

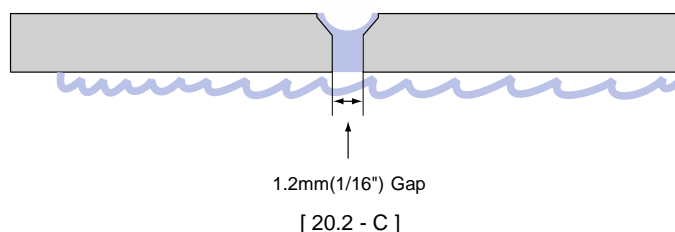

21.1 Food Service Application (Hot Wells)

Try to have all the hot wells next to each other.
Then, keep all the cold wells next to each other.

- Use 152mm(6") x 152mm(6") corner blocks - 45° all around.
- Make sure to have the corner cut out.
- (High strength corners)



[21.1 - A]

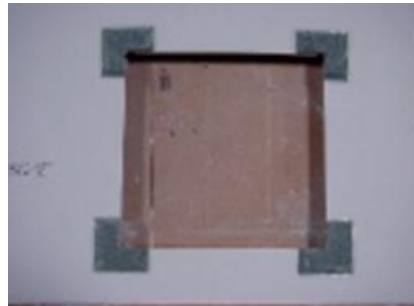

[21.1 - B]

- Round over with 3mm($\frac{1}{8}$ ") radius bit and sand smooth.
- 2-3 layers of heat tape- no gaps.
- Multiple hot wells- at least 76mm(3") between cutouts.
- Make sure the cabinets have ventilation. Heat needs to be dissipated.
- Round heat wells-Double up all the way around the cutout at least 51mm(2") beyond cutout.
- Round over with 3mm($\frac{1}{8}$ ") radius, top and bottom. Sand smooth.
- Put heat tape on round holes also.

21.2 Food Service Application (Cold Wells)

Treat cold wells the same as hot wells. The restaurant may decide to switch between the hot wells and cold wells at any time.
It is better to plan ahead.

22.1 Material Preparation

Material preparation is very important for successful thermoforming of Staron®.

1. Cut all pieces to their required dimensions.

➔ Note

Allow for material shrinkage and expansion during thermoforming.

2. Sand all material to a matte finish to remove any chips and scratches from edge that may cause tearing during forming. When designing, the minimum inside radius thermoformed as per Staron® thickness is as follows.

Sheet Thickness	Minimum Inside Radius	Remarks
6 mm (¼")	25 mm (1")	Solid, Sanded
	102 mm (4")	Aspen, Pebble
12 mm (½")	76 mm (3")	Solid, Sanded
	127 mm (5")	Aspen, Pebble
	203 mm (8")	Quarry, Metallic

[22.1 - A]

Quarry, Metallic and Tempest are not recommended for thermoforming.

If the sheet is bent to a radius smaller than the above values, the sheet may crack, craze, or whiten externally and / or internally.

22.2 Mould Preparation

Accurate moulds must be prepared before heating materials.

Make moulds from plywood or M.D.F. board in male / female sections to hold the heated sheet in the desired shape.

1. Cut the male and female mould from good quality plywood or M.D.F. board with a jig saw or router. The mould surface must be smooth and in good quality without any defects to prevent them from transferring onto the face of the Staron® to be thermoformed.
2. The internal part of the male and female moulds must be supported to endure pressure.
3. Do not use metal or solid wood, because these materials might absorb heat and slow the thermoforming and cooling process.

22.3 Oven

Having the right oven is essential for thermoforming. The oven has to be heated evenly (homogeneously) to get good result.

- The oven has to be designed for Staron® sheets and be heated to the same temperature at the same time.
- The oven has to be able to fully enclose the sheet. Heat it in a consistent and constant fashion with accurate and predictable control.

22.4 Oven Calibration

Oven must be correctly prepared and calibrated.

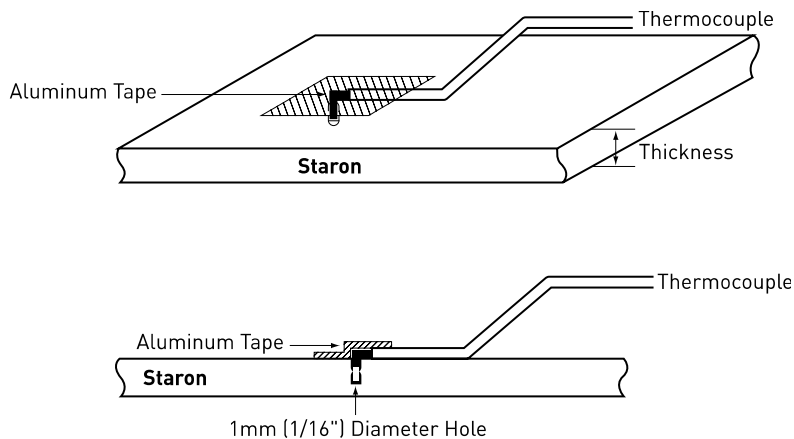

[22.4 - A]

- Drill a 1 mm (1/16") diameter hole halfway into a test piece of Staron®.
- Insert a thermocouple wire in the hole and the other thermocouple on the surface.
The thermocouples should be covered with aluminum tape.
To check two different temperatures.
- Check when the temperature in the hole reaches 293~302°F(145~150°C) and on the surface below 320°F (160°C) simultaneously. This will be the most effective time / temperature for your oven.
- Keep this profile during thermoforming.
- When the temperature in the hole reaches 293~302°F(145~150°C) and if the temperature on the surface is higher than 320°F(160°C), the heating power is too strong. Reduce the heating power.
- Remove the piece from the oven and allow it to cool until the thermometer reaches 180°F(82°C).
- Check the cool-down time.

22.5 Thermoforming

Thermoforming of Staron®

Staron® must be heated to a temperature between 293°F(145°C) and 330°F(165°C) for thermoforming. Lower temperatures may crack and whiten the Staron® material and higher temperatures will blister, whiten, or crack the material.

Heat up time will depend on oven design and the size of the piece to be thermoformed.

➔ Note

Uniformly heat the entire piece to prevent problems.

Recommended Time and Temperature guide is listed below.

However, running a test on a scrap piece is highly recommended to find the best time / temperature for the oven.

Sheet Thickness	Oven temperature	Heat up time
6 mm (¼")	302°F(150°C)	30~60 min
	347°F(175°C)	15~30 min
12.3mm (½")	302°F(150°C)	45~80 min
	347°F(175°C)	25~60 min

[22.5 - A]

▶ TIP

Temperature and time may vary depending on the oven.

It is highly recommended to test before final fabrication

22.6 Thermoforming Checklist

- Oven temperature should never exceed 347°F(175°C).
- Oven temperature exceeding 347°F(175°C) may overheat the surface of the sheet causing uneven distribution, causing problems.
- Before thermoforming Staron® sheet, calibrate the oven with a sample piece.
- Pre-heat the oven to the desired temperature.
- Place the piece of Staron® in the oven and start the timer.
- At the end of the calibrated time, remove the piece from the oven.
- Place the piece in the mould and clamp it securely.
- Reset the timer.
- At the end of the calibrated cool-down time, remove the piece from the mould and keep it under the atmosphere to cool to room temperature.

23.1 Introduction

The following Repair Techniques have been designed and compiled by Kevin Andreas of TEMPLATES BY ANDREAS. For any questions or to purchase tools described in the following repair section, please contact TEMPLATES BY ANDREAS directly.

The information and statements are believed to be reliable by both Lotte Chemical Corp. and TEMPLATES BY ANDREAS. However, it does not construe to assuming responsibility of any kind. Please undertake sufficient testing to determine suitability. Lotte Chemical Corp. and TEMPLATES BY ANDREAS disclaim any responsibility. It is important to test and take any necessary precaution to make sure the methods and products described are suitable to the user's specific needs.

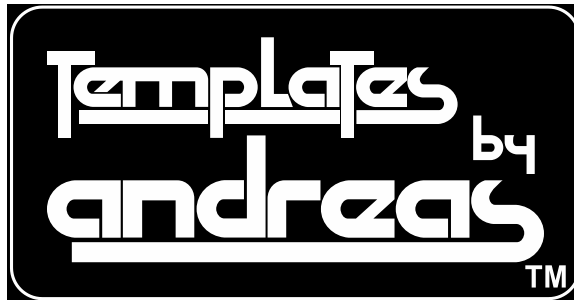

80 Black Meadow Road
Chester, NY 10918
1-800-935-5406

23.2 Inside Corner Repair

Inside Corner Repair

1. Sand the area to be repaired.
2. Encompass damaged area with pie shaped template and raise template with ¼" plywood shims.
3. Clamp to deck.
4. Using a 25mm(1") template guide and a 12mm(½") straight bit, rout through the deck only(leave thin outer layer of material).
5. Use wide router base to remove deck over buildup area.
6. Rout bevel into deck (deck thickness only) using bevel bit as shown.
7. Remove template.
8. Using plug template, mark a line on the buildup (this line will be 19mm(¾") over).
9. Slide template to line it up with the marks (no 6mm(¼") shims are needed.)
10. Using 25mm(1") template and 12mm(½") flute bit, route through damaged buildup.
11. Remove template
12. Hot melt 2 pieces of repair material (one at a time) to plug template and rout with 25mm(1") straight bit with bearing.
13. Slide repair buildup pieces into buildup and mark out backside to line up with existing buildup.
14. Either cut buildup repair pieces to exact size using 25mm(1") top bearing bit and two 25mm(1") x 50mm(2") strips hot melted to pieces
(this will leave a 12mm(½") radius at the inside corner) or rough cut pieces a 6mm(¼") over size with a jigsaw.
15. Make your deck plug the same as in steps #6 & #7 in Bevel Repair.
Each repair will act as seam plate to one another. All seams are 1" off the radius as required.
16. Glue up and sand.

Inside Corner Repair - Step by Step

1. Sand area to be repaired.
2. Encompass damaged area with pie shaped template and raise template with 6mm(¼") shims and clamp to deck.
3. Using 25mm(1") Template Guide and 12mm(½") straight bit, rout through deck only (leave onion skin material).
Use wide router base to remove deck over buildup area.
4. Rout bevel into deck (deck thickness only) using bevel bit as shown.

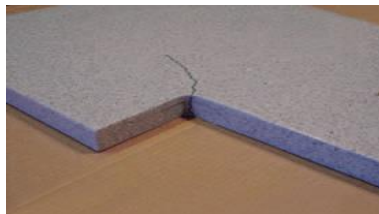

(1) Inside corner crack



(2) Encompass damaged area



(3) Rout with 12mm(½") straight bit 25mm(1") guide



(4) Rout bevel into counter

[24.2 - A]

5. Remove template. Deck is ready.
6. Using plug template, mark a line on buildup (this line will be ¾" over).
7. Slide template to line up with marks (no shims needed).
8. Using 1 template and 12mm(½") single flute bit, rout through damaged build-up (as shown).



(5) Remove template



(6) Mark out build up



(7) Line up template to marks



(8) Rout out cracked build up

[24.2 - B]

Inside Corner Repair - Step by Step

9. Remove template. Countertop is now ready.
10. Hot melt 2 pieces (1 at a time) of repair material to the plug template and rout with 25mm(1") top bearing straight bit.
11. Slide repair buildup piece into buildup and mark out (2 pieces).
12. Cut new buildup pieces even with existing buildup in rear while leaving a 6mm(¼") extra in the front.



(9) Remove template, counter is now ready



(10) Rout build up repair plug-2



(11) Fit and mark out plug



(12) Cut plug to size

[24.2 - C]

13. Make your deck plug the same as in step # 5 of the Bevel Repair, using the correct template. The buildup is repaired using a horizontal bevel, while the deck is repaired using a vertical bevel. Each repair will act as seam plate for one another. All seams are 25mm(1") off the radius as required. Glue up and sand.



(13) Mark top plug and glue up

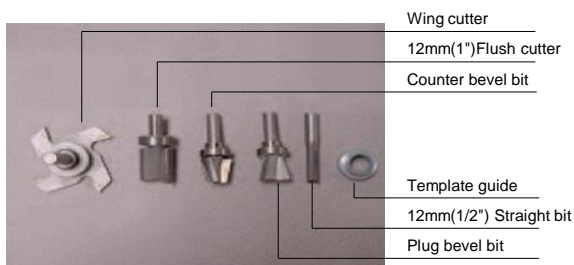

Repair template



For counters

For plugs

[24.2 - D]

23.3 Bevel Repair

Bevel Repair

1. Sand the area to be repaired so that all dirt/grease, etc. is removed.
2. Encompass entire crack with template. Attach template to deck using 4 18mm round size dabs of hot melt or by hot melting blocks around template to hold in place.
3. Rout out damaged area using a 12mm(1") template guide and 9.5mm($\frac{3}{8}$ ") or 12mm($\frac{1}{2}$ ") straight flute bit.
4. Using the counter bevel bit, rout opening of template. Allow bearing to have $\frac{1}{8}$ " to $\frac{1}{4}$ " coverage on template.
5. Remove the template with denatured alcohol and a chisel or putty knife.
6. Take the colour matched repair piece along with matching plug template and hot melt them together with the good side up.
7. Cut the repair piece 9.5mm($\frac{3}{8}$ ") bigger than the template.
8. Mount a plug bevel bit into the router table. Take the repair template with the colour matched repair piece hot melted to it and place it on to the router table with the template side resting on the router table.
Raise the bit up so bearing is within 3mm($\frac{1}{8}$ ") of the repair piece and let the template ride on the bearing.
9. With the templates still attached to the plug, place the plug in the counter.
If it is too high, lower the bit in the router table and re-route the plug, repeating the process until the plug fits flush with the countertop.
10. Remove the template from the plug as in step #5.
11. Clean all surfaces to be glued with denatured alcohol using clean white cloth.
12. Place aluminum tape on the underside of the counter cutout to stop glue from dripping.
13. Place aluminum tape on the good side of the plug with a 25mm(1") overhang to stop glue from dripping.
14. Apply glue to the plug and then the opening.
15. Place plug in opening pressing down firmly.
(No clamping is required or recommended since clamping may cause the piece to shift or build stress into the repair.)
16. Remove tape from plug and check for flushness with deck.
Plug should fit the same as it did when it was dry fit as in step #9.
17. Let adhesive cure and sand repair area flush with 80-grit sandpaper.
18. Once flush, change sandpaper to achieve desired finish.

Bevel Repair - Step by Step

1. Sand area to be repaired so all dirt / grease, etc. is removed.
This will allow clean seams / hot melt will hold templates better.
2. Hot melt template with 4 18mm round size dabs of glue to counter so crack is encompassed and rout using a 1" Template Guide and a 9.5mm(3/8") or 12mm(1/2") flute bit (leave template on).
3. Using alternate bevel bit (as shown) to route opening of template. Allow bearing to have 3mm(1/8") to 6mm(1/4") coverage on template.



(1) Hot pot cracks

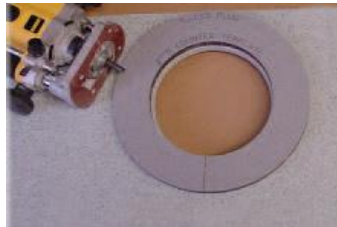

(2) Rout out damage with 12mm(1/2") straight bit 25mm(1") template guide
[24.3 - A]

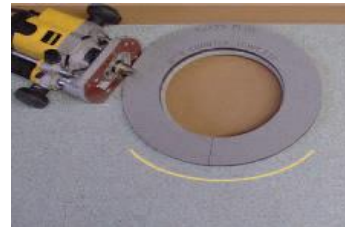

(3) Rout bevel into counter

4. Remove template with denatured alcohol and chisel or putty knife.
5. Take colour match piece and the matching plug template hot melt together both parts good side up.
Cut repair piece 9.5mm(3/8") bigger than the template (jigsaw ok).
6. Raise bit up so bearing is within 3mm(1/8") of repair piece and let template ride on bearing.
(This makes plug as big as possible, you can always make it smaller.)

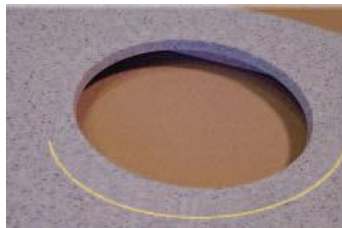

(4) Remove template and counter is ready



(5) Cut repair piece 9.5mm(3/8") bigger than template
Hot melt together



(6) Rout plug on router table

[24.3 - B]

7. With template still on plug test in counter. If it is too high, just lower bit in router table. This will make the plug smaller.
Repeat until plug is flush with top.
8. Remove template from plug. Clean all surfaces with white rag and denatured alcohol. Place aluminum tape on underside of counter cut out to stop glue from dripping, and place aluminum tape on good side of plug overhang 25mm(1") to stop glue from dripping. First apply glue to plug, then opening. Place plug in opening remove tape from plug and check for flushness with deck (no clamping required) just like a bevel mount sink.



(7) As you lower bit plug will become smaller

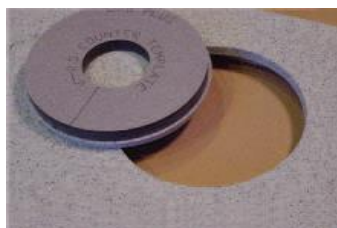

(8) Test plug for flushness with deck than glue up

[24.3 - C]

23.4 Solid Surface Sink Replacement

Solid Surface Sink Replacement

The following directions are for the removal of an average 406mm(16") x 533mm(21") sink using the Andreas Dustless Sink Template. Using this system the removal of the sink is virtually dustless. The template allows the fabricator to come within 25mm(1") of any obstruction, which means in most cases the top does not need to be removed.

The process takes between 63.5mm(2 ½") - 3 hours.

Solid Surface Sink Replacement - *Step by Step*

1. On the deck surface, measure back 25mm(1") from the inside of the sink on all 4 sides.
2. centre the appropriate Andreas Dustless Sink template between the marks.
3. Hot melt # 12mm(½") x 25mm(1") x 152mm(6") blocks around the template to hold it in place.
4. Secure the sink in place with a pipe clamp as shown in figure 24.4-A.
5. Tape off outside of counter / cabinet with blue painters tape (painters tape won't ruin the finish on the cabinets) to help control dust leakage from door cracks and other openings.
6. Use pipe foam to block the space between the top of the cabinet and the underside of the counter.



[24.4 - A]

7. Using a Dewalt #625 Router or equivalent set at 8000 RPMS (the router must be set at 8000 RPMS due to the size of the blade to insure safety and quality of the cut) insert the Andreas 152mm(6") dustless sink removal bit and the 16mm(5/8") template guide (figure 24.4-B) and align the blade to the seam as shown in figure 24.4-C.
8. Spray the blade with cutting lubricant and rout the backside of the sink first, keeping firm downward pressure on the router at all times.
9. Look at the shaft of the bit to insure the blade has completely stopped spinning then remove the router from the template.
10. Remove the template from the counter.
11. Vacuum dust from around the bottom of the template.



[24.4 - B]



[24.4 - C]

Solid Surface Sink Replacement - Step by Step

12. Apply aluminum tape around the back half of the sink seam that was just cut.
(This will hold the sink in place and prevent the sink from pinching the blade on the final sink cut).
13. To remove the front of the sink, turn the sink template 180 degrees and place it back on the countertop.
14. Cut out front of sink (router can move in a forward or backward direction due to its multi tooth design).
15. Again, look at the shaft of the bit to make sure that the blade has completely stopped spinning and then remove the router and the template.
16. Vacuum the template, the sink and the sink cabinet.
17. Remove old sink and inspect the cut where the sink was removed from the counter to insure a smooth cut and that all old flange has been removed.
18. Take the new sink and run aluminum tape 1.6mm(1/16") down from the edge of the bowl, under where the seam line is going to be.
19. Turn the tape up at a 90 degree angle to act as a gutter to catch excess glue from seaming.
20. Add the 203mm(8") extension and the donut to the pipe clamp setup as shown in figure 24.4-D.
21. Place the new sink onto the pipe clamp setup and raise it into the underside of the sink opening.
22. Place web clamps the counter over the sink and snug the new sink to counter making sure it is centered in old sink opening.
23. Clean dust off the surface, and then place sink clips around the sink at the web clamp openings with a generous amount of hot melt (figure 24.4-E and 24.4-F).



[24.4 - D]



[24.4 - E]

24. Remove the web clamp and lower the sink.
25. Clean the surface of the sink and the cutout.
26. Apply 6mm(¼") bead of seam adhesive to the sink flange approximately 6mm(¼") from the outside of the flange.
27. Raise the bowl back into the opening (sink clips will guide the bowl in exact location as before).
28. Replace web setup and tighten the clamp until a 3mm(⅛") + deflection is in the web clamp (figure 24,4 - F).
29. After adhesive is cured remove sink clips with denatured alcohol and sand with a Festool Rotex sander placed on direct drive with 80 grit sandpaper.
30. Switch the Festool Rotex sander back to random orbital drive and finish off with finer sandpaper as needed.

Changing a double sink will require two pipe clamp setups along with a double sink template and the appropriate web clamp.



[24.4 - F]

24.1 "10-YEAR LIMITED" WARRANTY (Residential)

Permanently installed Staron® Solid Surfaces sheets and shapes Lotte Chemical Corp. to the original owner. Staron® Solid Surfaces must be fabricated and installed by Staron® certified Fabricator/Installer, used and maintained in accordance with instructions provided by Lotte Chemical Corp. . Lotte Chemical Corp. at its sole option will repair or replace, without charge, such Product if it fails due to a manufacture defect during the first ten (10) years after the date of initial installation. This includes necessary real cost charges needed to repair or replace the Product. Although Lotte Chemical Corp. shall make its best effort to repair or replace with the best possible colour match to the original as possible, Lotte Chemical Corp. cannot guarantee the exact colour in the event of repair or replacement. All instructions for filling a claim under this limited warranty are available from your dealer and fabrication/installation source or by contacting Lotte Chemical Corp. directly.

This limited warranty is transferable during the 10-year period following initial installation only when the new owner notifies Lotte Chemical Corp. in writing.

This warranty excludes the following:

- | | |
|--|---|
| 01. Minor conditions such as stains, scratches, water spots and burns; | 11. Damage caused by excessive heat; or by an act of nature; |
| 02. Failure to comply with Lotte Chemical Corp. 's instructions including fabrication, installation, care, maintenance, etc; | 12. Workmanship of Fabricators or Installers; |
| 03. Any products moved from their original place of installation; | 13. Damages from other than manufacturing defect; |
| 04. Seam appearance of any adhesive, caulk or other accessory items; | 14. Any Product installed or located outdoors, such as outdoor kitchens, BBQ work surfaces, or in heated areas such as saunas, steam rooms, and shower pans; |
| 05. colour variation from the sample; | 15. In-Carton products including components made from Staron®; |
| 06. colour variation within different lots; | 16. Any Product installed in recreational vehicles; |
| 07. Exact colour match as a result of Product replacement or repair is not guaranteed; | 17. Any Product fabricated and installed in commercial applications; |
| 08. Failure caused by other substructure support; | 18. Fabrication, Installation, Modification or Repairs made by other than Staron® CFI (Certified Fabricator Installer); |
| 09. Misuse, abuse (including impact damage and contact with chemical reagents not intended for use with Product); | 19. Same colour and veined intensity between sheets in SUPREME collection. ((Veining may vary from sheet to sheet and also within a sheet. Special consideration has to be taken into any joint and coved up-stands.) |
| 10. Improper fabrication, installation, handling or maintenance; | |

Lotte Chemical Corp.'s obligation hereunder is limited solely to the repair or replacement including necessary reasonable real cost charges of the Products purchased hereunder. Except as to what is stated in this limited warranty herein, Lotte Chemical Corp. makes no warranties, express or implied, in respect to the Product, including, but not limited to, any implied warranty of merchantability or fitness for a particular purpose, and all such warranties hereby are expressly disclaimed. Lotte Chemical Corp. does not warrant that the Product will meet the end users' requirements. Lotte Chemical Corp. shall not be liable for incidental, consequential, indirect, special, punitive, or exemplary damages of any kind, including lost good will, lost profits, lost business, or other indirect economic damages, and further including injury to property, whether such claim is based on theories of contract, negligence, tort (including strict liability) or otherwise, as a result of breach of any warranty regardless of whether Lotte Chemical Corp. was advised, had other reason to know, or in fact knew of the possibility of such damages.

SOME COUNTRIES, STATES AND PROVINCES DO NOT ALLOW THE EXCLUSION OR LIMITATION STATED ABOVE, SO THE ABOVE EXCLUSION OR LIMITATION MAY NOT APPLY TO YOU. THIS LIMITED WARRANTY GIVES YOU SPECIFIC LEGAL RIGHTS. YOU MAY ALSO HAVE OTHER RIGHTS, WHICH WILL VARY FROM COUNTRY TO COUNTRY, STATE TO STATE OR PROVINCE TO PROVINCE

SN-804-2020

Warranty Service:

To request warranty service, contact your original fabricator/installer. You must present the original sales receipt or produce proof of purchase and installation of Staron[®] Solid Surfaces, which clearly proves the Product purchase and date of installation, in order to obtain service under this limited warranty. For more information about this warranty, please contact to Lotte Chemical Corp. at the address below:

Lotte Chemical Corp. EUROPE GMBH
Kölner Str. 12 65760 Eschborn, Germany
TEL +49 6196 77 272 75

DUBAI OFFICE
Flat No 1702, Arenco Tower, Media City, Dubai, UAE. 48969
Tel. +971-4-245-1403

This warranty cannot be modified, amended, or in any way altered except by an instrument in writing signed by an authorized officer of Lotte Chemical Corp..

Effective as September, 2015

24.2 "10-YEAR LIMITED" WARRANTY (Commercial)

Staron® Solid Surfaces sheets and shapes by Lotte Chemical Corp. permanently installed in an approved indoor commercial applications is warranted against material defects. This limited warranty is non-transferable during the 10-year period and is limited to the original owner of the project, and is not transferable or assignable and this limited warranty expires if sold, transferred or assigned.

This warranty excludes the following:

- | | |
|--|--|
| 01. Minor conditions such as stains, scratches, water spots and burns; | 10. Improper fabrication, installation, handling or maintenance; |
| 02. Failure to comply with Lotte Chemical Corp. 's instructions including fabrication, installation, care, maintenance, etc; | 11. Damage caused by excessive heat; or by an act of nature; |
| 03. Any products moved from their original place of installation; | 12. Workmanship of Fabricators or Installers; |
| 04. Seam appearance of any adhesive, caulk or other accessory items | 13. Damages from other than manufacturing defect; |
| 05. colour variation from the sample; | 14. Any Product installed or located outdoors, such as outdoor kitchens, BBQ work surfaces, or in heated areas such as saunas, steam rooms, and shower pans; |
| 06. colour variation within different lots; | 15. In-Carton products including components made from Staron®; |
| 07. Exact colour match as a result of Product replacement or repair is not guaranteed; | 16. Any Product installed in recreational vehicles; |
| 08. Failure caused by other substructure support; | 17. Same colour and veined intensity between sheets in SUPREME collection. ((Veining may vary from sheet to sheet and also within a sheet. Special consideration has to be taken into any joint and coved up-stands.)) |
| 09. Misuse, abuse (including impact damage and contact with chemical reagents not intended for use with Product); | |

Lotte Chemical Corp., at its sole option, will determine whether to provide materials necessary for repair or replacement due to the Product manufacturing defects. Except as to what is stated in this limited warranty herein, Lotte Chemical Corp. makes no warranties, express or implied, in respect to the Product, including, but not limited to, any implied warranty of merchantability or fitness for a particular purpose, and all such warranties hereby are expressly disclaimed. Lotte Chemical Corp. does not warrant that the Product will meet the end users' requirements. Lotte Chemical Corp. shall not be liable for incidental, consequential, indirect, special, punitive, or exemplary damages of any kind, including lost good will, lost profits, lost business, or other indirect economic damages, and further including injury to property, whether such claim is based on theories of contract, negligence, tort (including strict liability) or otherwise, as a result of breach of any warranty regardless of whether Lotte Chemical Corp. was advised, had other reason to know, or in fact knew of the possibility of such damages.

SOME COUNTRIES, STATES AND PROVINCES DO NOT ALLOW THE EXCLUSION OR LIMITATION STATED ABOVE, SO THE ABOVE EXCLUSION OR LIMITATION MAY NOT APPLY TO YOU. THIS LIMITED WARRANTY GIVES YOU SPECIFIC LEGAL RIGHTS. YOU MAY ALSO HAVE OTHER RIGHTS, WHICH WILL VARY FROM COUNTRY TO COUNTRY, STATE TO STATE OR PROVINCE TO PROVINCE.

Warranty Service:

To request warranty service, contact your original fabricator/installer. You must present the original sales receipt or produce proof of purchase and installation of Staron® Solid Surfaces, which clearly proves the Product purchase and date of installation, in order to obtain service under this limited warranty. For more information about this warranty, please contact to Lotte Chemical Corp. at the address below:

This warranty cannot be modified, amended, or in any way altered except by an instrument in writing signed by an authorized officer of Lotte Chemical Corp..

Effective as September, 2015

24.3 Complaint Handling Procedure

□ Complaint from end customer AFTER INSTALLATION

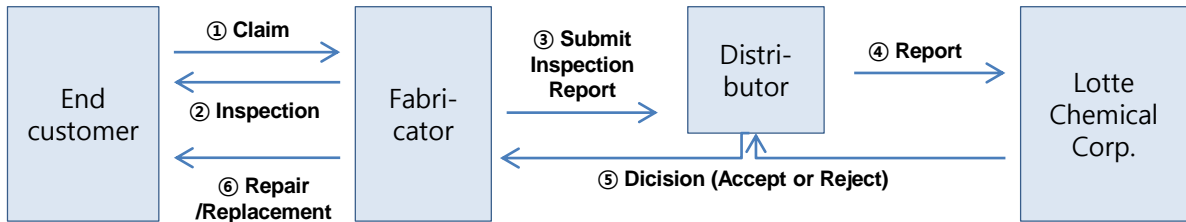

1. General rule follows “Staron 10 years limited warranty (Residential and Commercial)”
2. The project should be warranty registered. <https://www.staron.com/staron/uk/technical/bulletin/warranty.do>
 - * All repair work that covered by LOTTE ADVANCED MATERIALS should be done by Staron Quality Partner who installed the claimed project. If Staron Quality Partner is not available, Staron training centre should arrange the repair job.
 - * Any labor cost from the fabrication will be billed at cost of labor but without margin premium.

□ Complaint from fabricator or installer BEFORE INSTALLATION

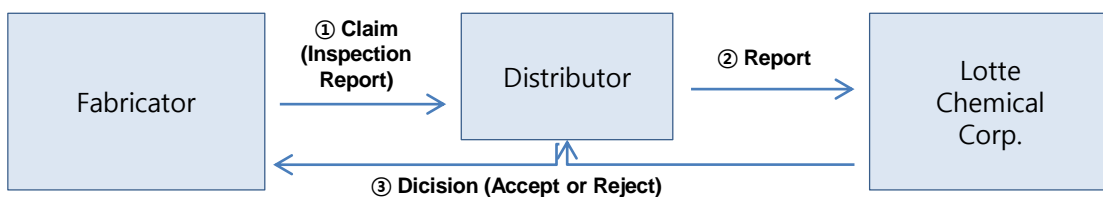

1. Lotte Chemical Corp. will replace materials which do not meet our product specification when delivered. Product inspection prior to fabrication, see chapter 2. “Quality Inspection”
2. Once the product is unpacked, checked and deemed satisfactory for fabrication then fabrication is started, this means that product has been accepted as suitable and consequently, the limited product warranty expires.
3. In the case defects appear during fabrication such as black spots, patchiness, air pits (voids), bad particle separation appear during sanding and the quantity of those problems are outside our Staron® standards, the product will be replaced.
*Note: Dark colours such as Onyx require more careful sanding to reach an acceptable result.
 Sanding darker colours will require much more time and susceptible to scratching once in use*
 - * Lotte Chemical Corp. replacement policy does not allow for any labor charges incurred during or after fabricating on the defective materials.

24.4 Specific Warranty Stipulations

SUBJECT	Warranty Information
Product inspection	Inspect sheets and shapes products prior to fabrication. replacement policy does not allow for labour on defective material
Sinks & Bowls colour	Same solid colour sheets and shapes may not colour-match exactly.
Supreme collection	The supreme collection offers a unique vein pattern on one side and more pronounced veins on the other. The pattern on the supreme collection sheets are random and are not guaranteed to have the same colour and veined intensity between sheets.
Dark & Sensitive Colours	Dark and sensitive colours are best used for decorative purpose only. Avoid using these colours where heavy use will be apparent. Refer to chapter 1. "Products". All dark colours marked. As dark, solid colours require more care to maintain their appearance. Lotte Chemical Corp. gives no warranty on scratching or staining to the surface.
Tools	The following tools must not be used in any circumstances to cut Staron : Jig saws, ripping or combination blades, auger bits.
Sharp edges	All small cuts or fractures in a Staron® cut may lead to cracking when the sheet is subject to stress. The best way to eliminate stress from saw cuts is to rout all sawn edges with a spindle moulder or router with a sharp straight cutting tool. The upper and lower edge of the cut-out must have a 1,5 mm radius. In all cases of edge details and downturns, after gluing, all sharp edges must be eased and relieved by sanding or routing (R > 1,5 mm). It is essential that the top and bottom edges (of holes for taps) are sanded to avoid stress rises.
Reinforced seams	All seams in Staron® countertops must be reinforced. All Staron® seams next to a heat source must be reinforced. Seams should not be positioned through a heat source. All reinforcing strips must be where heat appliances are situated.
Dishwasher & seams	Seams should not be positioned over a dishwasher.
Dishwasher insulation	Always put insulating material directly over any dishwasher, between the dishwasher and the Staron® countertop. Check for dishwasher position and fit insulation (i.e. Rockwool or equivalent) between the dishwasher and the Staron® countertop.

24.4 Specific Warranty Stipulations (continued-1)

SUBJECT	Warranty Information
Peripheral expansion gap	Each countertop requires 1.5 mm between each wall, therefore a minimum of 3 mm overall. An expansion gap of 3 mm minimum should be allowed in order to comply with the Staron warranty.
Expansion gap around hob	The gap between the body of the under box and the edge of the cut-out should be a minimum of 6 mm (i.e. 3mm all around) The dimensions in the figure should provide 3 mm to 6 mm clearance between appliance and the cut-out. The cut-out must be minimum 3 mm larger all round than the box of the hob. Allow a minimum of 3mm to 6 mm gap between the cut-out and the electrical appliance.
Off-set internal corner	Reinforced seams have to be positioned at a minimum of 35 mm from the internal corner.
Staron® Joint Adhesive	Staron® Joint Adhesive is exclusive to Staron® and is the only adhesive Lotte Chemical Corp. warranties when seaming Staron®.
Carousel cabinets	Most carousel type cabinets provide inadequate support for inside corners in Staron® countertops and therefore need to be properly supported. Corner base units may require timber battens fastened against the back wall to support the Staron® countertop. Some corner cabinets with revolving shelves require additional support in the front.
Inlays	Inlays do not fall within the Staron® warranty.
High-strength cut-out & edges	The mandatory method for installing square hobs is the high-strength cutout. The upper and lower edge of the cut-out must have a 1.5 mm radius and the cut-out must be wrapped with aluminium reflective tape. Unless the hob is installed according to the above mentioned specifications, the Staron® warranty is void. Top and bottom edges must be sanded until they are round and smooth to a minimum radius of 1.5 mm.
Gas hobs	To avoid damage to the full height backsplash a minimum space of 100 mm is required between the appliance and the Staron® cladding to dissipate the hot gasses/heat.
Flush-mounted hob	Flush-mounted hob units, integrated in the Staron® countertop, are not encouraged and will only be covered by the Lotte Chemical Corp. warranty if the fabrication/installation procedures are followed:

24.4 Specific Warranty Stipulations (continued-2)

SUBJECT	Warranty Information
Full underlayment	<p>Do not use full underlayment. Staron® 12 mm is better used with frame support e.g. heat dispersion. Dust covers in cabinets can act like underlayment and should neatly be removed, unless the customer objects.</p> <p>With kitchen base units which have solid tops (dust covers) the central portion should be removed leaving a perimeter of approx. 50 to 75 mm. This will allow heat to dissipate but not weaken the base unit construction.</p>
Frame support	<p>Front and side frame support is mandatory. Frame support cross members are highly recommended to add strength to the construction and allow fixing to cabinets.</p> <p>Divisional supports can be added to enhance fixing or additional strength.</p>
High-gloss finish	<p>High-gloss finish is more sensitive and requires constant care and attention to maintain its look. The consumer should be clearly advised of the special care needed and prevent inadequate expectations.</p> <p>High-gloss finish should never be recommended for kitchens or vanity units, but mainly for decorative purposes. They are not suitable for any surface which is in working use.</p>
6, 9 mm sheets	<p>6 mm Staron® sheets are to be used in vertical applications only.</p> <p>9 mm Staron® sheets are not recommended for horizontal application with heat source.</p> <p>The 10 year limited warranty on 6 mm and 9 mm applies only to above cases.</p>
Wall cladding	<p>Staron® does not recommend that wall cladding be adhered to backsplashes or countertops with Staron® Joint Adhesive.</p>
Do not screw into Staron®	<p>Drill all holes to take face fixing 3 mm larger than the screw to be used.</p> <p>Screwing directly into Staron® is not allowed and will invalid Staton warranty.</p>
Staron® Cut-out piece	<p>Place the cut-out piece of colour-matched material hidden in an appropriate place such as underneath a drawer or behind the kick-board of the cabinets. It will prove to be useful in case repair material is needed.</p>
Vertical application	<p>Do NOT fix Staron® in saunas, swimming pools or steam rooms as such. Due to the influences of constant exposure to moisture and humidity, the coefficient expansion and contraction are impossible to control. Applications as such are not covered by the Lotte Chemical Corp. warranty.</p> <p>Special sub-construction and fixing methods need to be foreseen. Dark, sensitive colours should not be used in a shower application.</p>

24.4 Specific Warranty Stipulations (continued-3)

SUBJECT	Warranty Information
3-Dimensional thermoforming	<p>Staron® product warranty is limited to the products made by Lotte Chemical Corp. (i.e. its range of sheets, shapes and accessories). The installed warranty is limited to installations made in accordance with the technical stipulations mentioned in the technical literature.</p> <p>Lotte Chemical Corp. warranties the Staron® sheet performance only in sheet like applications.</p> <p>3-dimensional thermoformed shapes (e.g. shower tray, bowl, bath etc.) made with Staron® and resulting from an additional production process on the Staron® sheet/shape as produced by Lotte Chemical Corp., do not carry the product warranty of Lotte Chemical Corp..</p>
Chemical resistance	<p>It is good practice to install a test piece of material to confirm the suitability of performance for the application. Please refer to Staron® Technical bulletin "Chemical resistance"</p>
Creating drainer boards	<p>If you wish to reduce the countertop to create a drainer board the cut should not exceed 5 mm in depth in 12 mm Staron® Below this area a insulation material should be applied to the underside of the Staron® sheet.</p> <p>If the design desires drainer grooves to be deeper than 5 mm in 12 mm Staron® you are to laminate a second thickness of 12 mm Staron® to the underside of this area to add strength to comply with our 10 year installation warranty.</p>
Hob appliances	<p>As per the international standard norm (IEC 335-2-36) the temperature rise of a hob appliance onto the surface around is limited to 65K (= 65° C + room temperature => 85° C)</p> <p>If cracks happen around the hob and temperatures are measured above this norm then the 10 year installed warranty is void.</p>